

GARDEN 2022

Lawn and Soil Care
Tree and Shrub Care
Watering and Drainage





THE EINHELL GUARANTEE PROMISE.

We develop our products so that you can make everything possible. Our priority here is functionality, safety and quality. That is our promise and this is backed up by our guarantees too.

- **30 Day Money-Back Guarantee**
For 100% satisfaction with your Power X-Change device.
- **Power X-Change Battery Warranty**
Warranty extension for Power X-Change batteries to 2 years.
- **Einhell 2+1 Product Warranty**
Warranty extension for all Einhell products to a total of 3 years.



THIS IS HOW:

Find out more at einhell.de, register in your customer account and apply for the warranty. Further information is available at www.einhell.de/warranties

einhell.de
>>>



POWER X-CHANGE

Power X-Change The Most Competent Battery System	6	Cordless Telescopic Hedge Trimmers	35
Power X-Change Robot Lawn Mowers	10	Cordless Chainsaws	36
Petrol Lawn Mower (Power X-Change Electric Start)	14	Cordless Chain Sharpener	38
Cordless Lawn Mowers	15	Cordless Leaf Blowers	39
Cordless Push Reel Mower	20	Cordless Universal Blower	41
Cordless Universal Spreader	20	Cordless Leaf Vacuums	42
Cordless Scarifiers/Aerators	21	Cordless Grass and Shrub Shears	44
Cordless Tillers	21	Cordless Pruning Saw	45
Cordless Earth Auger	22	Cordless Pruning Shears	45
Cordless Snow Thrower	22	Cordless Pressure Sprayers	46
Cordless Scythes	23	Battery Belt	47
Cordless Lawn Trimmers	24	Cordless Hot Air Generator	47
Cordless Lawn Edge Trimmer	27	Cordless Garden Pump	48
Cordless Grout Cleaner	27	Cordless Clear Water Pumps	49
Cordless Surface Brush	28	System Cases E-Case	52
Cordless Hedge Trimmers	30	Power X-Change Accessories	54
Cordless Multifunctional Tools	33	E-Kickscooter ELMOTO KICK	57
Cordless Pole-Mounted Pruners	34	The Battery Guide – Running Time Tables	58



GARDEN CARE

Lawn and Soil Care	62	Tree and Shrub Care	81
Robot Lawn Mower	63	Electric Hedge Trimmers	83
Electric Lawn Mowers	65	Petrol Hedge Trimmer	84
Petrol Lawn Mowers	66	Cordless Grass and Shrub Shears	85
Manual Lawn Mowers	70	Electric Pole-Mounted Pruner	86
Electric Scarifiers/Aerators	72	Electric Telescopic Hedge Trimmers	87
Petrol Scarifier	73	Electric Multifunctional Tool	87
Garden Roller	74	Electric Chainsaws	89
Electric Grout Cleaner	74	Petrol Chainsaws	90
Multi-Purpose Spreader	74	Electric Chain Sharpeners	91
Electric Lawn Trimmers	75	Woodworking Accessories	91
Petrol Lawn Trimmer	76	Electric Leaf Vacuums	92
Petrol Multifunctional Tool	76	Garden Shredders	93
Petrol Scythes	77	Electric Roller Shredders	93
Petrol Tillers	79		
Electric Tillers	80		



WATER TECHNOLOGY

Watering / Drainage / Domestic Water Supply	94	Surface Pumps 'Plus'	108
'Aqua Sensor' Clear Water Pump	98	Garden Pumps 'Plus'	110
'Aqua Sensor' Dirty Water Pumps	99	Garden Pumps	112
2-in-1 Multi-Purpose Pumps	100	Automatic Home and Garden Pumps 'Plus'	114
Submersible Pumps Dirty/Clear Water 'ECO'	102	Automatic Home and Garden Pumps	115
Dirty Water Pumps	102	Water Works 'Plus'	116
Clear Water Pumps	104	Water Works	118
Rain Barrel Pump	105	Petrol Water Pumps	119
Submersible Pressure Pumps	106	Surface Pumps Accessories	121
Deep Well Pumps	107		

Accessories + Spare Parts	122
Sales Support	132

Service	134
----------------	------------

EINHELL IS GOLD PARTNER OF FC BAYERN!



WE ARE PARTNER. EINHELL AND FC BAYERN.

In our search for a partner for whom performance and endurance are just as important as they are for us, who values power and flexibility and consistently pursues their goals, we have found what we were looking for: As of August 2021, **Einhell as Gold Partner has been appointed as an Home & Garden Expert of FC Bayern.** Whether on the pitch or around the Allianz Arena: Be there when we implement exciting projects with the power and garden tools of our Power X-Change battery system enabling the players to **make everything possible** on the pitch.



"We need people by our side who love what they do. Who have mastered their technique. Who take us forward. We need a partner with whom we can make any mission possible. And there can only be one."

Oliver Kahn, CEO, FC Bayern München AG

A PARTNERSHIP. ON THE SAME LEVEL.

Inspire people by giving your all every day. Working as a team with performance and perseverance to meet every challenge. And thereby convince with their own technology and competence. Einhell and FC Bayern not only share a love of their home in the heart of Bavaria, but especially also common values and the same mindset. As the team behind the FC Bayern team, we are now the club's Official Home and Garden Expert, the experts and enablers for smooth match and training operations.

Powerful enabler meets German record champion. The mission? Enabling the Next Level!

BATTERY EXPERTISE. CONVINCING. AGAIN AND AGAIN.

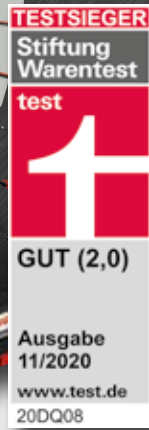

"We are incredibly proud to have done so well in a race with the very top competitors and to have been able to demonstrate our battery expertise so clearly. We are battery test winners."

Andreas Kroiss, CEO, Einhell Germany AG



WE ARE TEST WINNERS. BY STIFTUNG WARENTEST.



And the test winner is ... Einhell! In the comparison test performed by Stiftung Warentest (11/2020 issue) covering eight batteries from eight different battery platforms, the 2.0 Ah battery from Einhell's Power X-Change battery system beat off stiff competition. Our battery put in a convincing performance when it came to durability, handling and safety. Having already achieved top marks with Power X-Change machines in previous

Stiftung Warentest comparisons, we are all the more delighted that one of the batteries we have spent so much time developing and refining came out of the test on top. This confirms the decision we took years ago to bundle our expertise in the battery technology sector in order to continue expanding the leading role of our Power X-Change battery system.



**CORDLESS FREEDOM.
FOR TOOL AND GARDEN.**

At last – no more too short or severed cables.

When you no longer have to worry about extension cables that are too short or sufficient sockets. When the device comes to the project instead of the other way round. When you simply insert the battery and are ready to go, whether it is a lawn mower, garden pump, rotary hammer or wet and dry vacuum cleaner. That is the feeling of cordless freedom.



**LATEST TECHNOLOGY.
PROVEN QUALITY.**

So you can enjoy using your machine for a very long time.

The Power X-Change batteries are the centerpiece of the platform. That is why we use only the best components such as high-performance Li-Ion cells and our intelligent ABS battery electronics in the batteries. This makes our PXC battery one of the safest in the industry and ensures efficiency, reliability and durability. Stiftung Warentest (11/2020 issue) confirmed its quality in a comparison test with eight batteries from eight different battery platforms. The 2.0 Ah battery from the Power X-Change battery system from Einhell beat off stiff competition to emerge as test winner.



**POWERFUL MACHINES.
LONG-LASTING BATTERIES.**

No matter how large your project – Power X-Change won't let you down.

Less power? No way! As a battery system for real enablers, our cordless machines offer up to 2700 Watt of battery power and 8 Ah of capacity, making them easily a match for corded machines! Whether you just want to hang a shelf or drill through a solid concrete wall, with Power X-Change you are equipped to meet any challenge with power and endurance.



**1 BATTERY. 1000 POSSIBILITIES.
FOR DIY ENTHUSIASTS AND HOBBY GARDENERS.**

Just as versatile as you: Battery power for every situation.

Power X-Change is the first rechargeable battery system that provides hobby gardeners and DIY enthusiasts alike with an unrivaled selection of cordless tools. The PXC family already contains over 200 devices – and the number is constantly rising. Thanks to the versatile Power X-Change system, for instance, the electric kick scooter from GOVECS is “powered by Power X-Change”.



ACTIVE BATTERY MANAGEMENT SYSTEM. INTELLIGENT ELECTRONIC CONTROL SYSTEM.

The computer-assisted Active Battery Management System permanently monitors and controls all the safety-related processes of the electrical components and associated hardware. This results in a whole range of advantages:

- MAXIMISED RUNNING TIMES
- OPTIMISED TOOL POWER
- LONGER BATTERY SERVICE LIFE
- INCREASED SAFETY



TWIN-PACK® TECHNOLOGY. 18 V + 18 V = 36 V.

If a device needs more power than provided by a single 18 V rechargeable battery, we simply add a second battery so we generate 18 V + 18 V = 36 V. We call that Twin-Pack® Technology.

If the voltage (V) gets doubled, the power (W) gets doubled, too. Double Twin-Pack Technology in turn makes it possible to work for even longer still without the nuisance of recharging. In this case, four rechargeable batteries are used. When the power of the first two batteries finally runs out, the system automatically switches over to the two additional batteries.



POWER X-CHANGE PLUS. THE PLUS IN POWER.

Rechargeable batteries vary not just in terms of running time and weight. What is also critically important is the power that they provide. Power X-Change PLUS Technology makes more power available from the same number of cells, so that you can work with plenty of power even on challenging applications as well.

If, for example, you want to use your angle grinder for cutting work, the running time (see Ah rating) is generally not critical. Sufficient power, on the other hand, is. A car is a useful comparison. Uphill or when overtaking, more power, in other words more hp respectively kW, is needed.

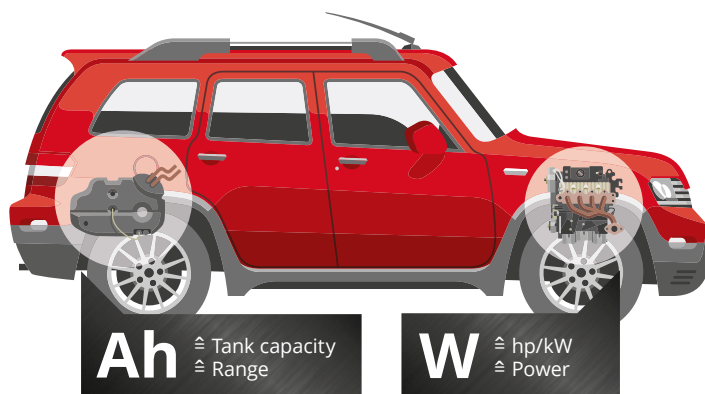

BRUSHLESS ENERGY – MORE EFFICIENT WORK.

Various Power X-Change devices are equipped with brushless motors. They offer significant advantages compared to carbon brush motors:

- MORE POWER
- LONGER RUNNING TIMES
- LONGER SERVICE LIFE
- MORE COMPACT DESIGN
- MAINTENANCE-FREE



25%
+ more power*

50%
+ more operating time*

100%
+ more service life*

* Approximate values in comparison to conventional carbon brush motors



Einhell

CORDLESS EXCELLENCE.



1 BATTERY.

FOR MORE THAN 200 TOOLS.



ONLY FROM EINHELL.

POWER X-CHANGE ROBOT LAWN MOWERS

Power X-Change Robot Lawn Mower
FREELEXO 750 LCD BT+



RAIN SENSOR
for lawn-friendly operation



MULTI-AREA MOWING FUNCTION
for complicated gardens



APP
Control via smart phone through Bluetooth



SAFETY SENSOR SYSTEM
Impact, lift and tilt sensor for maximum safety



ECO MODE
Constantly saving power – good for the wallet and the environment



ANTI-THEFT PROTECTION
in form of PIN code



PROGRAMMABLE OPERATING TIME
for each specific day



SPOT MOWING
Targeted mowing for hard-to-reach places, such as under garden furniture



LCD DISPLAY
(only FREELEXO+) for easier control on the product



SILENT
Your garden – your oasis of silence



SEPARATE AREAS OF THE GARDEN
Mowing mode for complex gardens with separate areas of grass

DISCOVER EINHELL'S POWER X-CHANGE ROBOT LAWN MOWERS.

Whether small gardens or large areas of grass, with different Power X-Change robot mower models, accessory kits and setting options you have the right robot for every garden.

There are 2 ways to an individual Freelexo set tailored exactly to your garden:

TWO WAYS TO GET YOUR FREELEXO

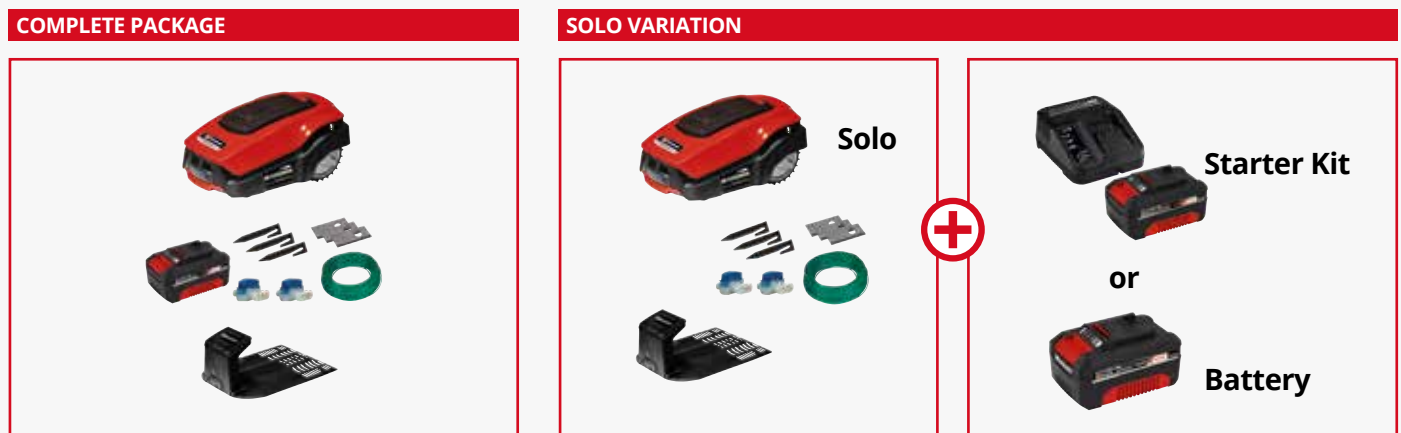

**POWER X-CHANGE
ROBOT LAWN MOWERS**



Solo and complete packages in ascending order of mowing area	FREELEXO 300 Solo EXPERT	FREELEXO 350 EXPERT	FREELEXO 400 BT EXPERT	FREELEXO 450 BT Solo EXPERT
PXC battery voltage / capacity	18 V / -	18 V / 2.0 Ah	18 V / 2.0 Ah	18 V / -
For lawn areas of up to approx.*	300 m ²	350 m ²	400 m ²	450 m ²
Cutting width	18 cm	18 cm	18 cm	18 cm
Cutting height adjustment	infinitely / 20 - 60 mm / central	infinitely / 20 - 60 mm / central	infinitely / 20 - 60 mm / central	infinitely / 20 - 60 mm / central
Suitable for slopes up to	35 %	35 %	35 %	35 %
PXC system battery	•	•	•	•
App (Bluetooth)	-	-	•	•
LCD display	-	-	-	-
Programmable operating time for each specific day	-	-	•	•
Multi area mowing	-	-	•	•
Spot Mowing	-	-	-	-
Mowing program for border areas	•	•	-	-
Eco mode	•	•	-	-
Impact, lift and tilt sensors	•	•	•	•
Brushless motor	•	•	•	•
Supplied with charging unit	•	•	•	•
Number of batteries / number of chargers	0 / 0	1 / 0	1 / 0	0 / 0
Supplied with perimeter wire	100 m	110 m	120 m	125 m
Supplied with fastening hooks	140 St.	150 pcs	170 pcs	180 pcs
Supplied with accessories	3 connecting clamps, 3 blades	3 connecting clamps, 3 blades	3 connecting clamps, 3 blades	3 connecting clamps, 3 blades
Article number	34.139.61	34.139.62	34.139.48	34.139.44

* The stated area coverage is based on the assumption of ideal conditions



CHARGING UNIT INCLUDED

A charging unit is included with every robot lawn mower, whether Kit or Solo.



Illustration may differ from the original



QUALITY CONFIRMED

A range of test institutes confirm the high quality of our Power X-Change robot lawn mowers through very good test results.



POWER X-CHANGE ROBOT LAWN MOWERS



Solo and complete packages in ascending order of mowing area	FREELEXO 500 BT EXPERT	FREELEXO 500 LCD BT+ EXPERT NEW	FREELEXO 600 BT EXPERT	FREELEXO 750 LCD BT+ EXPERT
PXC battery voltage / capacity	18 V / 2.5 Ah	18 V / 2.5 Ah	18 V / 2.5 Ah	18 V / 3.0 Ah
For lawn areas of up to approx.*	500 m ²	500 m ²	600 m ²	750 m ²
Cutting width	18 cm	18 cm	18 cm	18 cm
Cutting height adjustment	infinitely / 20 - 60 mm / central	infinitely / 20 - 60 mm / central	infinitely / 20 - 60 mm / central	infinitely / 20 - 60 mm / central
Suitable for slopes up to	35 %	35 %	35 %	35 %
PXC system battery	•	•	•	•
App (Bluetooth)	•	•	•	•
LCD display	-	•	-	•
Programmable operating time for each specific day	•	•	•	•
Multi area mowing	•	•	•	•
Spot Mowing	-	•	-	•
Mowing program for border areas	-	•	-	•
Eco mode	-	•	-	•
Impact, lift and tilt sensors	•	•	•	•
Brushless motor	•	•	•	•
Supplied with charging unit	•	•	•	•
Number of batteries / number of chargers	1 / 0	1 / 0	1 / 0	1 / 0
Supplied with perimeter wire	130 m	130 m	140 m	175 m
Supplied with fastening hooks	190 pcs	190 pcs	200 pcs	245 pcs
Supplied with accessories	3 connecting clamps, 3 blades	3 connecting clamps, 3 blades	3 connecting clamps, 3 blades	3 connecting clamps, 3 blades
Article number	43.263.63	34.139.82	34.139.46	34.139.81



* The stated area coverage is based on the assumption of ideal conditions

ROBOT LAWN MOWERS ACCESSORIES

	Article number	EAN	Items supplied	Suitable for
Perimeter Wire	34.140.21	4 006825 648782	1 pc (50 m)	all Einhell lawn mowers
Spare Blades	34.140.20	4 006825 648775	12 pcs	
Fastening Hooks	34.140.23	4 006825 648805	100 pcs	
Connection Clamps	34.140.22	4 006825 648799	4 pcs	
Repair Kit	34.140.26	4 006825 657968	5 m perimeter wire, 15 fastening hooks, 8 connecting clamps	
Cleaning Set	34.140.25	4 006825 657951	Gloves, brush, scouring pad, microfiber cloth, screwdriver, spatula	

POWER X-CHANGE ROBOT LAWN MOWERS



Solo and complete packages in ascending order of mowing area	FREELEXO 800 LCD BT Solo EXPERT	FREELEXO 900 LCD BT EXPERT	FREELEXO 1200 LCD BT EXPERT
PXC battery voltage / capacity	18 V / -	18 V / 3.0 Ah	18 V / 5.2 Ah
For lawn areas of up to approx.*	800 m ²	900 m ²	1200 m ²
Cutting width	18 cm	18 cm	18 cm
Cutting height adjustment	infinitely / 20 - 60 mm / central	infinitely / 20 - 60 mm / central	infinitely / 20 - 60 mm / central
Suitable for slopes up to	35 %	35 %	35 %
PXC system battery	•	•	•
App (Bluetooth)	•	•	•
LCD display	•	•	•
Programmable operating time for each specific day	•	•	•
Multi area mowing	•	•	•
Spot Mowing	-	-	-
Mowing program for border areas	-	-	-
Eco mode	-	-	-
Impact, lift and tilt sensors	•	•	•
Brushless motor	•	•	•
Supplied with charging unit	•	•	•
Number of batteries / number of chargers	0 / 0	1 / 0	1 / 0
Supplied with perimeter wire	180 m	190 m	210 m
Supplied with fastening hooks	250 pcs	270 pcs	300 pcs
Supplied with accessories	3 connecting clamps, 3 blades	3 connecting clamps, 3 blades	3 connecting clamps, 3 blades
Article number	34.139.53	34.139.55	43.263.68



* The stated area coverage is based on the assumption of ideal conditions

ROBOT LAWN MOWERS ACCESSORIES



	Robot Lawn Mower Garage
Items supplied	1 pc
Foldable	•
Length x width x height	77.0 x 59.0 x 39.5 cm
Suitable for	all Einhell robot lawn mowers
Article number	34.140.24



PETROL LAWN MOWER (POWER X-CHANGE ELECTRIC START)



	GC-PM 46 SM HW-E Li CLASSIC NEW
Engine / displacement	4-stroke engine / 146 cm ³
Power / working speed	2.0 kW / 2900 min ⁻¹
PXC battery voltage / capacity	1x 18 V / 2.0 Ah
Charging time	2.5 h
Cutting width	46 cm
Cutting height adjustment	9 levels / 25 - 80 mm / central
Grass box capacity	65 l
Wheel diameter front / rear	204 mm / 280 mm
Housing material	Powder-coated sheet steel
For lawn areas of up to approx.	1400 m ²
Product weight	32.5 kg
Highwheels	•
Self-propelling	•
Electric start function with PXC battery (18 V)	•
Mulching function	•
Height-adjustable long handle with soft grip	•
Grass box with level indicator	•
Lawn comb	•
Number of batteries / number of chargers	1 / 1
Article number	34.075.60



POWER X-CHANGE ELECTRIC START

Easy-to-start petrol engine thanks to the electric start function with the assistance of the Power X-Change battery system – at just the push of a button:

- None of the hassle of starting up with a pull starter
- The rechargeable battery can also be used for other Power X-Change products



CORDLESS LAWN MOWERS



CENTRAL CUTTING HEIGHT ADJUSTMENT
User-friendly and easy cutting height adjustment

SIDE DISCHARGE
Perfectly suited for use in tall grass

DOUBLE TWIN-PACK TECHNOLOGY
Longer mowing without recharging

STEEL DECK
Exceptionally sturdy, robust and long-lasting

SOFT GRIP
Ergonomic and fatigue-proof operation

VARIABLE WHEEL DRIVE
Optimum adjustment of the speed to user requirements and the height of the grass

75 L NYLON CATCH BAG WITH FILL LEVEL INDICATOR
Optimum catching and filling characteristics

Cordless Lawn Mower
GP-CM 36/47 S HW Li

MORE POWER AND LONGER OPERATING TIMES
The brushless motor guarantees both maximum power and longer operating times per battery charge on top of all the other advantages

CORDLESS LAWN MOWERS



36 V POWER
2 x 18 V

DOUBLE TWINPACK TECHNOLOGY

GP-CM 36/47 S HW Li PROFESSIONAL	
PXC battery voltage / capacity	4x 18 V / 4.0 Ah
Charging time	75 min
For lawn areas of up to approx.*	700 m ²
Cutting width	47 cm
Cutting height adjustment	6 levels / 30 - 65 mm / central
Grass box capacity	75 l
Wheel diameter front / rear	200 mm / 280 mm
Housing material	Steel
Product weight	35.7 kg
Variable wheeldrive	•
Mulching function	•
Integrated carry handle	•
Brushless motor	•
Height-adjustable handlebar	•
Folding handlebar	•
Grass box with level indicator	•
Wide wheels exert less stress on the lawn	•
Number of batteries / number of chargers	4 / 2 (Twincharger)
Cleaning tool	•
Article number	34.132.00

DOUBLE TWINPACK TECHNOLOGY

DOUBLE TWIN-PACK TECHNOLOGY

Double Twin-Pack devices have slots for two additional rechargeable batteries. If, for example, two additional batteries are inserted in the GP-CM 36/47 S HW Li lawn mower, such that all four rechargeable battery slots are filled, you can mow double the area without recharging.

Example (GP-CM 36/47 S HW Li):
Twinpack 2x 18 V = 350 m²
Double Twinpack
2x 18 V + 2x 18 V =
350 m² + 350 m² = 700 m²

* The stated area coverage is based on the assumption of ideal conditions



CORDLESS LAWN MOWERS



36 V POWER
2 x 18 V

DOUBLE TWINPACK TECHNOLOGY

	GE-CM 36/48 Li M - Solo EXPERT NEW
PXC battery voltage / capacity	2x 18 V / -
Charging time	-
For lawn areas of up to approx.*	-
Cutting width	48 cm
Cutting height adjustment	6 levels / 30 - 75 mm / axial
Grass box capacity	-
Wheel diameter front / rear	180 mm / 180 mm
Housing material	Steel
Product weight	17.1 kg
Mulching function	•
Integrated carry handle	-
Brushless motor	•
Height-adjustable handlebar	•
Folding handlebar	•
Grass box with level indicator	-
Wide wheels exert less stress on the lawn	•
Number of batteries / number of chargers	0 / 0
Article number	34.130.54



CORDLESS LAWN MOWERS

36 V POWER
2 x 18 V

BRUSHLESS ENERGY
Einhell



	GE-CM 36/43 Li M (2x 4.0 Ah) EXPERT NEW	GE-CM 36/43 Li M - Solo EXPERT	RASARRO 36/42 PROFESSIONAL
PXC battery voltage / capacity	2x 18 V / 4.0 Ah	2x 18 V / -	2x 18 V / 4.0 Ah
Charging time	75 min	-	75 min
For lawn areas of up to approx.*	600 m ²	-	550 m ²
Cutting width	43 cm	43 cm	42 cm
Cutting height adjustment	6 levels / 25 - 75 mm / central	6 levels / 25 - 75 mm / central	6 levels / 25 - 75 mm / central
Grass box capacity	63 l	63 l	50 l
Wheel diameter front / rear	160 mm / 250 mm	160 mm / 250 mm	150 mm / 220 mm
Housing material	Plastic	Plastic	Plastic
Product weight	16.5 kg	16.5 kg	15.0 kg
Mulching function	•	•	•
Integrated carry handle	•	•	•
Brushless motor	•	•	•
Height-adjustable handlebar	•	•	•
Folding handlebar	•	•	•
Grass box with level indicator	•	•	•
Wide wheels exert less stress on the lawn	•	•	•
Number of batteries / number of chargers	2 / 2	0 / 0	2 / 1 (Twincharger)
Article number	34.132.40	34.132.46	34.132.70



* The stated area coverage is based on the assumption of ideal conditions

CORDLESS LAWN MOWERS

36 V
POWER
2 x 18 V

BRUSHLESS ENERGY
Einhell



	GP-CM 36/41 Li - Solo PROFESSIONAL	RASARRO 36/38 PROFESSIONAL
PXC battery voltage / capacity	2x 18 V / -	2x 18 V / 4.0 Ah
Charging time	-	75 min
For lawn areas of up to approx.*	-	450 m ²
Cutting width	41 cm	38 cm
Cutting height adjustment	6 levels / 25 - 75 mm / central	6 levels / 25 - 75 mm / central
Grass box capacity	50 l	45 l
Wheel diameter front / rear	150 mm / 220 mm	150 mm / 220 mm
Housing material	Plastic	Plastic
Product weight	15.0 kg	15.5 kg
Mulching function	-	•
Integrated carry handle	•	•
Brushless motor	•	•
Height-adjustable handlebar	•	•
Folding handlebar	•	•
Grass box with level indicator	•	•
Wide wheels exert less stress on the lawn	•	•
Number of batteries / number of chargers	0 / 0	2 / 1 (Twincharger)
Article number	34.132.75	34.131.80



CORDLESS LAWN MOWERS

36 V
POWER
2 x 18 V



	GE-CM 36/37 Li EXPERT	GE-CM 36/37 Li - Solo EXPERT
PXC battery voltage / capacity	2x 18 V / 3.0 Ah	2x 18 V / -
Charging time	60 min	-
For lawn areas of up to approx.*	400 m ²	-
Cutting width	37 cm	37 cm
Cutting height adjustment	6 levels / 25 - 75 mm / central	6 levels / 25 - 75 mm / central
Grass box capacity	45 l	45 l
Wheel diameter front / rear	150 mm / 220 mm	150 mm / 220 mm
Housing material	Plastic	Plastic
Product weight	14.4 kg	14.4 kg
Mulching function	-	-
Integrated carry handle	•	•
Brushless motor	-	-
Height-adjustable handlebar	•	•
Folding handlebar	•	•
Grass box with level indicator	•	•
Wide wheels exert less stress on the lawn	•	•
Number of batteries / number of chargers	2 / 2	0 / 0
Article number	34.131.70	34.131.72



* The stated area coverage is based on the assumption of ideal conditions

CORDLESS LAWN MOWERS

36 V
POWER
2 x 18 V

BRUSHLESS ENERGY
Einhell

TESTSIEGER
Schwungmäher GUT (2,0)
Test
+
Angebot 10/11
10/11



	GE-CM 36/36 Li EXPERT	GE-CM 36/34-1 Li - Solo EXPERT	GE-CM 36/33 Li EXPERT
PXC battery voltage / capacity	2x 18 V / 4.0 Ah	2x 18 V / -	2x 18 V / 2.5 Ah
Charging time	75 min	-	50 min
For lawn areas of up to approx.*	400 m ²	-	250 m ²
Cutting width	36 cm	33.5 cm	33 cm
Cutting height adjustment	6 levels / 25 - 75 mm / central	5 levels / 25 - 65 mm / central	5 levels / 25 - 65 mm / central
Grass box capacity	40 l	30 l	30 l
Wheel diameter front / rear	145 mm / 220 mm	150 mm / 180 mm	150 mm / 180 mm
Housing material	Plastic	Plastic	Plastic
Product weight	13.4 kg	11.9 kg	11.6 kg
Mulching function	-	-	-
Integrated carry handle	•	•	•
Brushless motor	•	-	-
Height-adjustable handlebar	•	•	•
Folding handlebar	•	•	•
Grass box with level indicator	•	•	•
Wide wheels exert less stress on the lawn	•	•	•
Number of batteries / number of chargers	2 / 2	0 / 0	2 / 2
Article number	34.132.30	34.132.26	34.132.10

* The stated area coverage is based on the assumption of ideal conditions



**CORDLESS
LAWN MOWERS**



	GE-CM 18/33 Li EXPERT	GE-CM 18/33 Li - Solo EXPERT	GE-CM 18/32 Li - Solo EXPERT
PXC battery voltage / capacity	18 V / 4.0 Ah	18 V / -	18 V / -
Charging time	75 min	-	-
For lawn areas of up to approx.*	200 m ²	-	-
Cutting width	33 cm	33 cm	32 cm
Cutting height adjustment	5 levels / 25 - 65 mm / central	5 levels / 25 - 65 mm / central	3 levels / 30 - 70 mm / axial
Grass box capacity	30 l	30 l	25 l
Wheel diameter front / rear	150 mm / 180 mm	150 mm / 180 mm	140 mm / 140 mm
Housing material	Plastic	Plastic	Plastic
Product weight	11.6 kg	11.6 kg	8.5 kg
Mulching function	-	-	-
Integrated carry handle	•	•	•
Brushless motor	•	•	•
Height-adjustable handlebar	•	•	-
Folding handlebar	•	•	•
Grass box with level indicator	•	•	-
Wide wheels exert less stress on the lawn	•	•	•
Number of batteries / number of chargers	1 / 1	0 / 0	0 / 0
Article number	34.132.60	34.132.66	34.132.56



**CORDLESS
LAWN MOWERS**



	GE-CM 18/30 Li EXPERT	GE-CM 18/30 Li - Solo EXPERT
PXC battery voltage / capacity	18 V / 3.0 Ah	18 V / -
Charging time	60 min	-
For lawn areas of up to approx.*	150 m ²	-
Cutting width	30 cm	30 cm
Cutting height adjustment	3 levels / 30 - 70 mm / axial	3 levels / 30 - 70 mm / axial
Grass box capacity	25 l	25 l
Wheel diameter front / rear	140 mm / 140 mm	140 mm / 140 mm
Housing material	Plastic	Plastic
Product weight	8.0 kg	8.0 kg
Mulching function	-	-
Integrated carry handle	•	•
Brushless motor	•	•
Height-adjustable handlebar	-	-
Folding handlebar	•	•
Grass box with level indicator	-	-
Wide wheels exert less stress on the lawn	•	•
Number of batteries / number of chargers	1 / 1	0 / 0
Article number	34.131.55	34.131.57



* The stated area coverage is based on the assumption of ideal conditions

CORDLESS PUSH REEL MOWER



	GE-HM 18/38 Li - Solo EXPERT
PXC battery voltage / capacity	18 V / -
Cutting width	38 cm
Cutting height adjustment	4 levels / 14 - 38 mm
Grass box capacity	45 l
Number of mowing blades	5
Mowing spindle diameter	125 mm
Product weight	11.5 kg
Mulching function	•
Integrated carry handle	-
Brushless motor	-
Height-adjustable handlebar	•
Folding handlebar	•
Wide wheels exert less stress on the lawn	•
Number of batteries / number of chargers	0 / 0
Article number	34.142.00



CORDLESS UNIVERSAL SPREADER



	GE-US 18 Li - Solo EXPERT
PXC battery voltage / capacity	18 V / -
Capacity	3.3 l
Spread width	max. 5 m
Suitable for	Fertiliser, grass seed and salt
Product weight	1.2 kg
Electronic speed control (6-stage)	•
Flow rate adjustment (8-stage)	•
Individually adjustable spread width	•
Soft grip	•
Suitable for winter grit	•
Number of batteries / number of chargers	0 / 0
Article number	34.154.10



CORDLESS SCARIFIERS/AERATORS

**36 V
POWER
2 x 18 V**



BRUSHLESS ENERGY
Einhell



BRUSHLESS ENERGY
Einhell



	GE-SC 35/1 Li - Solo EXPERT	GC-SC 36/31 Li - Solo CLASSIC	GC-SC 18/28 Li - Solo CLASSIC NEW
PXC battery voltage / capacity	2x 18 V / -	2x 18 V / -	18 V / -
For lawn areas of up to approx.*	400 m ²	350 m ²	200 m ²
Working width	35 cm	31 cm	28 cm
Working depth adjustment	3 levels (central) + transport position	3 levels (central) + parking position	3 levels (central) + parking position
Number of blades	16 pcs	8 double-knives	12 pcs
Wheel diameter front / rear	175 mm / 152 mm	180 mm / 100 mm	150 mm / 100 mm
Housing material	Plastic	Plastic	Plastic
Product weight	9.8 kg	9.5 kg	6.6 kg
Wide wheels exert less stress on the lawn	•	•	•
Brushless motor	•	-	•
Height-adjustable handlebar	• + parking position	•	•
Folding handlebar	•	•	•
Optional extensible (aerator roller/catch bag)	•	•	•
Integrated carry handle	•	•	•
Quick fasteners	•	-	-
Number of batteries / number of chargers	0 / 0	0 / 0	0 / 0
Article number	34.206.50	34.206.60	34.206.04

* The stated area coverage is based on the assumption of ideal conditions



CORDLESS TILLERS



	GE-CR 30 Li - Solo EXPERT	GE-CR 18/20 Li E - Solo EXPERT NEW
PXC battery voltage / capacity	2x 18 V / -	18 V / -
Working width	30 cm	20 cm
Working depth	200 mm	200 mm
Number of blades	4 pcs	4 pcs
Cultivator blade diameter	200 mm	155 mm
Housing material	Plastic	Plastic
Product weight	11.0 kg	5.5 kg
Height-adjustable wheels for easy transportation	•	-
Ergonomic handlebar	•	•
Folding handlebar	•	Split shaft
Electronic speed control	-	•
Number of batteries / number of chargers	0 / 0	0 / 0
Article number	34.312.00	34.312.10



CORDLESS EARTH AUGER



	GP-EA 18/150 Li BL - Solo PROFESSIONAL NEW
PXC battery voltage / capacity	18 V / -
Drilling diameter	150 mm
Drill bit length	800 mm
Speed	125 min ⁻¹
Product weight	5.7 kg
Brushless motor	•
Drill bit change without tools	•
Metal frame	•
Clockwise / counter-clockwise operation	•
Soft grip	•
Number of batteries / number of chargers	0 / 0
Article number	34.370.00



CORDLESS SNOW THROWER



	GE-ST 36/40 Li E - Solo EXPERT NEW
PXC battery voltage / capacity	2x 18 V / -
Working width	40 cm
Max. snow height	20 cm
Throwing distance max.	6 m
Housing material	Plastic
Product weight	6.5 kg
Brushless motor	•
Snow ejection direction adjustable	•
Electronic speed control	•
Battery cover	•
Additional handle	•
Integrated carry handle	•
Soft grip	•
Self-standing	•
Two-hand safety switch	•
Number of batteries / number of chargers	0 / 0
Article number	34.170.11



CORDLESS EARTH AUGER ACCESSORIES



	Earth Auger 120 mm NEW	Mortar Mixer NEW	Extension NEW
Suitable for	GP-EA 18/150 Li BL	GP-EA 18/150 Li BL	GP-EA 18/150 Li BL
Article number	34.370.10	34.370.11	34.370.12



CORDLESS SCYTHES

ELECTRONIC SPEED CONTROL
Controlled and precise operation

SPINDLE-LOCK SYSTEM
Easy change of the cutting equipment

FRONT-MOTOR
Perfect power transmission and weight balance

MORE POWER AND LONGER OPERATING TIMES
The brushless motor guarantees both maximum power and longer operating times per battery charge on top of all the other advantages

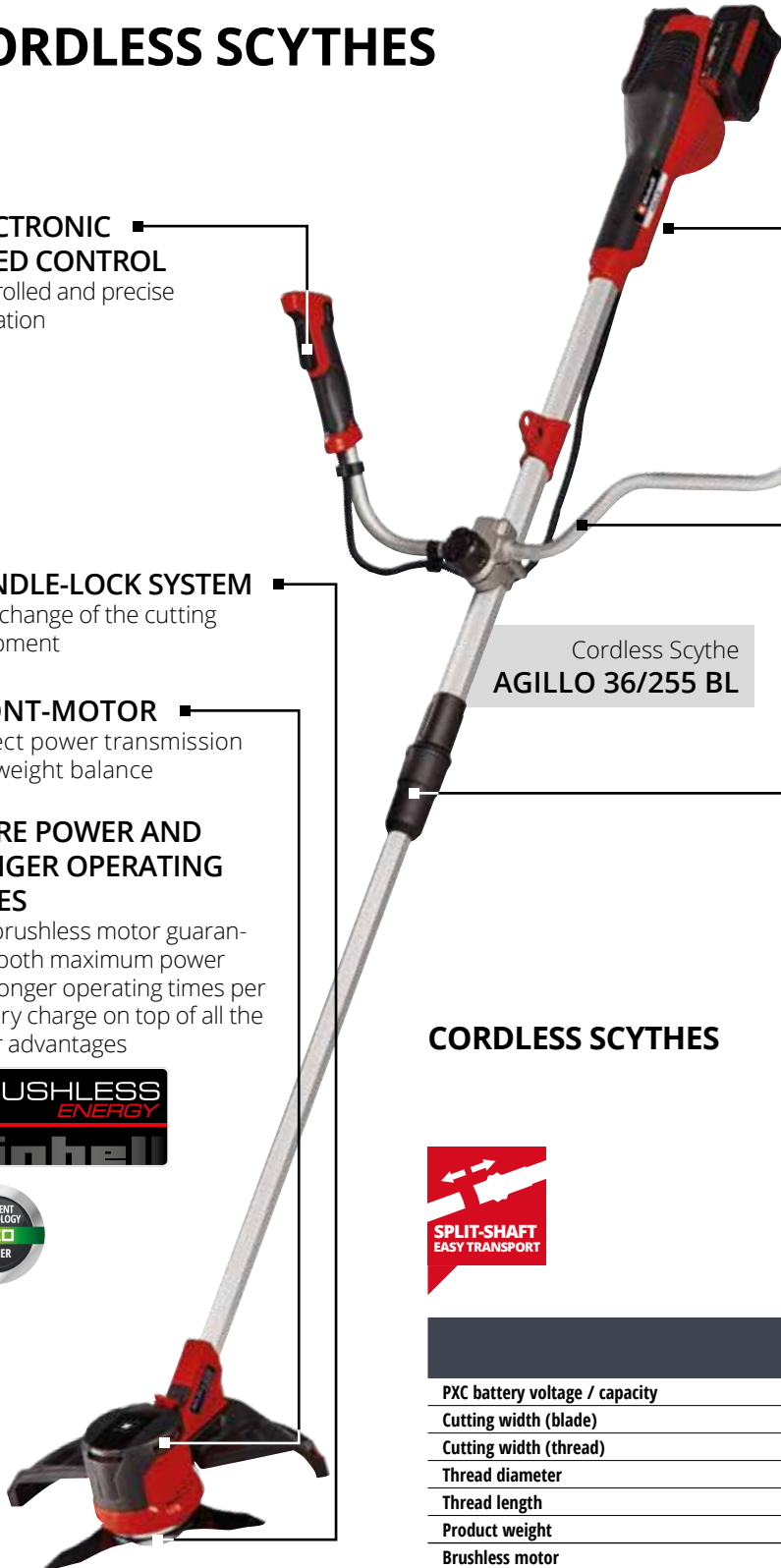

Cordless Scythe
AGILLO 36/255 BL

WALL BRACKET
Easy and space-saving storage

SOFT GRIP
Ergonomic and fatigue-proof operation

SECOND HANDLE
The universally adjustable second handle (bike handle) enables the scythe to be guided safely and comfortably

SPLIT SHAFT
User-friendly plug-together system for stowing away quickly and compactly and for easy transport

CORDLESS SCYTHES



	AGILLO 36/255 BL EXPERT	AGILLO 18/200 EXPERT
PXC battery voltage / capacity	2x 18 V / -	18 V / -
Cutting width (blade)	25.5 cm	20 cm
Cutting width (thread)	30 cm	30 cm
Thread diameter	2.0 mm	2.0 mm
Thread length	8 m	8 m
Product weight	6.5 kg	6.8 kg
Brushless motor	•	-
Spindle Lock	•	•
Adjustable handle	•	•
Split shaft	•	•
Bike handle	•	•
Electronic speed control	•	•
Automatic jog line feed	•	•
Wall bracket	•	•
Number of batteries / number of chargers	0 / 0	0 / 0
Blades	•	•
Thread spool	•	•
Comfort harness	•	•
Article number	34.113.20	34.113.10



4 006825 629583



4 006825 651300

CORDLESS LAWN TRIMMERS

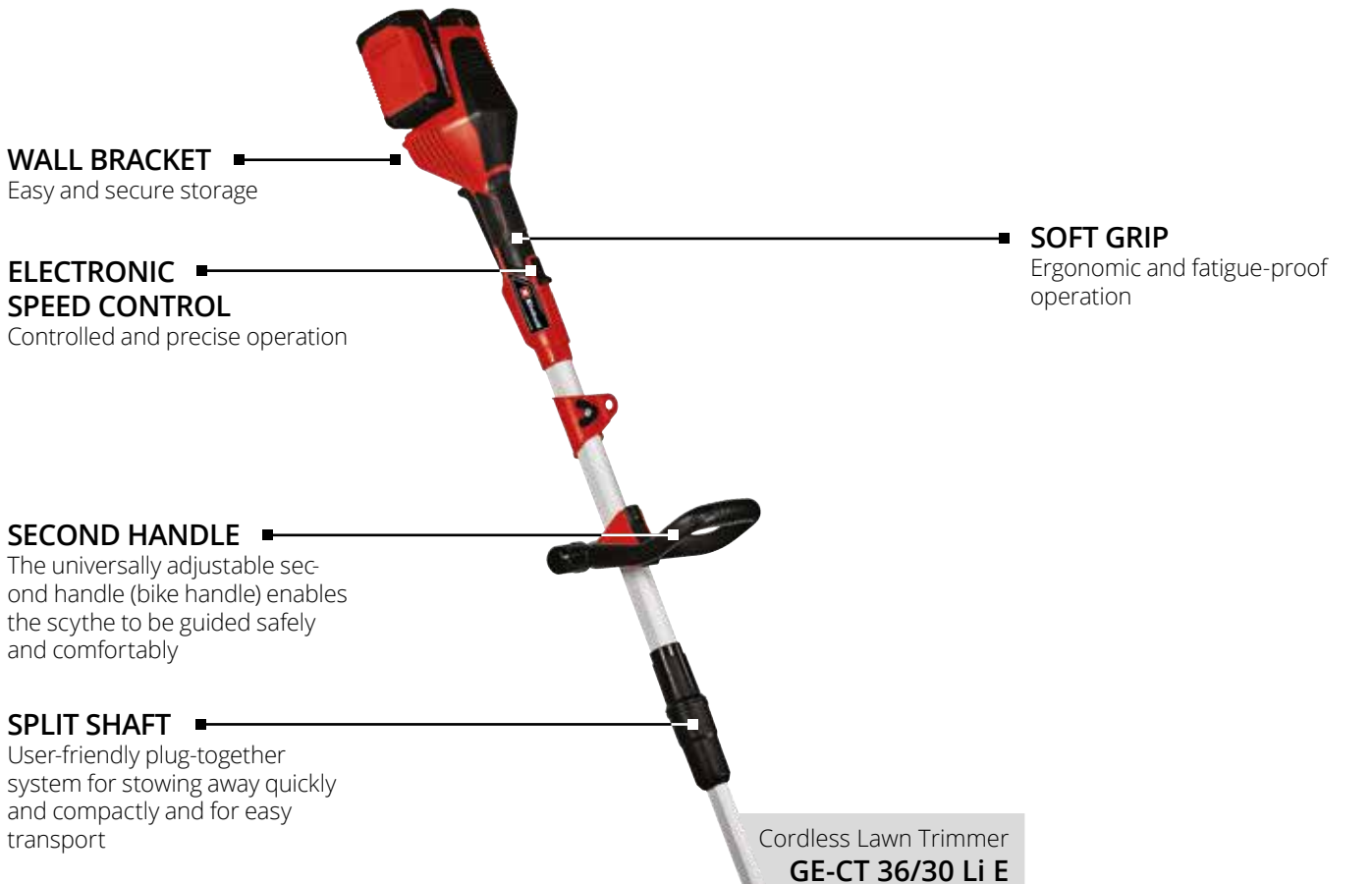

WALL BRACKET
Easy and secure storage

ELECTRONIC SPEED CONTROL
Controlled and precise operation

SOFT GRIP
Ergonomic and fatigue-proof operation

SECOND HANDLE
The universally adjustable second handle (bike handle) enables the scythe to be guided safely and comfortably

SPLIT SHAFT
User-friendly plug-together system for stowing away quickly and compactly and for easy transport

Cordless Lawn Trimmer
GE-CT 36/30 Li E

CORDLESS LAWN TRIMMERS

36 V POWER
2 x 18 V

SPLIT-SHAFT EASY TRANSPORT



	GE-CT 36/30 Li E - Solo EXPERT
PXC battery voltage / capacity	2x 18 V / -
Cutting width	30 cm
Thread diameter	2.0 mm
Thread length	8 m
Product weight	4.2 kg
Infinitely adjustable long handle	•
Flower guard	•
Automatic jog line feed	•
Split shaft	•
Electronic speed control	•
Soft grip	•
Wall bracket	•
Number of batteries / number of chargers	0 / 0
Thread spool	•
Carrying strap	•
Article number	34.113.00



LINE SPOOL
The single-line spool with bump feed produces a clean cut edge over a width of up to 30 centimeters

FRONT-MOTOR
Perfect power transmission and weight balance

FLOWER GUARD
Always ensures the necessary safe distance from flowers and ornamental plants



CORDLESS LAWN TRIMMERS



	GE-CT 18/30 Li - Solo EXPERT NEW	GE-CT 18/28 Li TC - Solo EXPERT NEW	GE-CT 18/28 Li - Solo EXPERT NEW
PXC battery voltage / capacity	18 V / -	18 V / -	18 V / -
Cutting width	30 cm	28 cm	28 cm
Thread diameter	1.6 mm	1.6 mm	1.6 mm
Thread length	5 m	5 m	5 m
Product weight	2.1 kg	5.0 kg	2.2 kg
Adjustable handle	•	•	•
Telescopic long handle	•	•	•
Motor head rotateable	90°	180°	180°
Motor head can be tilted	3 settings	3 settings	3 settings
Flower guard	•	•	•
Storage compartment for spare blades	-	-	-
Soft grip	•	•	•
Trimmer cart	-	•	-
Automatic feeding line spool	-	•	•
Number of batteries / number of chargers	0 / 0	0 / 0	0 / 0
Article number	34.112.50	34.112.12	34.112.42



CORDLESS LAWN TRIMMERS



	GE-CT 18 Li EXPERT	GE-CT 18 Li - Solo EXPERT
PXC battery voltage / capacity	18 V / 2.0 Ah	18 V / -
Charging time	40 min	-
Max. running time	55 min	-
Cutting width	24 cm	24 cm
Product weight	2.2 kg	1.8 kg
Infinitely adjustable long handle	•	•
Telescopic long handle, infinitely adjustable	•	•
Motor head rotateable +/- 90°	•	•
Motor head can be tilted	5 settings	5 settings
Flower guard	•	•
Storage compartment for spare blades	•	•
Soft grip	•	•
Number of batteries / number of chargers	1 / 1	0 / 0
Plastic blades included	• (20 pcs)	• (20 pcs)
Article number	34.111.97	34.111.72



CORDLESS LAWN TRIMMERS



	GC-CT 18/24 Li CLASSIC	GC-CT 18/24 Li - Solo CLASSIC	GC-CT 18/24 Li P CLASSIC	GC-CT 18/24 Li P - Solo CLASSIC
PXC battery voltage / capacity	18 V / 2.0 Ah	18 V / -	18 V / 1.5 Ah	18 V / -
Charging time	40 min	-	120 min	-
Max. running time	55 min	-	40 min	-
Cutting width	24 cm	24 cm	24 cm	24 cm
Product weight	1.8 kg	1.8 kg	1.2 kg	1.2 kg
Infinitely adjustable long handle	•	•	-	-
Telescopic long handle, infinitely adjustable	•	•	-	-
Motor head rotateable +/- 90°	-	-	-	-
Motor head can be tilted	-	-	-	-
Flower guard	•	•	-	-
Storage compartment for spare blades	-	-	-	-
Soft grip	-	-	-	-
Number of batteries / number of chargers	0 / 0	0 / 0	1 / 1	0 / 0
Plastic blades included	• (20 pcs)	• (20 pcs)	• (20 pcs)	• (20 pcs)
Article number	34.111.25	34.111.23	34.111.02	34.111.04



CORDLESS LAWN EDGE TRIMMER



	GE-LE 18/190 Li - Solo EXPERT
PXC battery voltage / capacity	18 V / -
Charging time	-
Max. running time	-
Min. cutting depth	36.5 mm
Max. cutting depth	45 mm
Blade length	190 mm
Product weight	3.0 kg
Infinitely adjustable long handle	•
Split shaft	•
Cutting depth adjustment	•
Rollers	•
Soft grip	•
Number of batteries / number of chargers	0 / 0
Article number	34.243.00



CORDLESS GROUT CLEANER



	GC-CC 18 Li CLASSIC	GC-CC 18 Li - Solo CLASSIC
PXC battery voltage / capacity	18 V / 2.0 Ah	18 V / -
Charging time	40 min	-
Max. running time	45 min	-
Diameter of brush	100 mm	100 mm
Product weight	2.4 kg	2.0 kg
Infinitely adjustable long handle	•	•
Telescopic long handle, infinitely adjustable	•	•
Guide wheel	•	•
Soft grip	•	•
Number of batteries / number of chargers	1 / 1	0 / 0
Steel brush (15 mm wide)	•	•
Steel brush (10 mm wide)	- (available as an accessory)	- (available as an accessory)
Nylon brush (10 mm wide)	•	•
Nylon brush (6 mm wide)	- (available as an accessory)	- (available as an accessory)
Article number	34.240.51	34.240.50



CORDLESS SURFACE BRUSHES

4-IN-1 FUNCTION

Cleaning/freshening up of stone, wood, artificial turf and corners and edges

INCL. WATER CONTROL VALVE

Economical use of water by manually regulation possibility directly on the machine



INTEGRATED GARDEN HOSE CONNECTION

Easy, complete and thorough wet cleaning in just one step

INTEGRATED SIDE BRUSH

The special side brush is suitable for perimeter work right up the edge



Cordless Surface Brush **PICOBELLA**



ELECTRONIC SPEED CONTROL

Allows individual adjustment to every surface

ADDITIONAL HANDLE

with a practical integrated garden hose routing

TELESCOPIC ALUMINIUM TUBE

The telescopic aluminium tube can be adjusted to individual requirements for back-friendly operation

BRUSH CHANGE WITHOUT TOOLS

Brushes can be changed easy and quickly at the press of a button

FORWARDS/REVERSE BRUSH OPERATING

For better cleaning results, smooth brush guidance and perfect splash protection



Surface Brush **SOFT**



Surface Brush **MEDIUM**
(incl. side brush)



Surface Brush **ULTRA**



Side Brush **ULTRA**

CORDLESS SURFACE BRUSHES

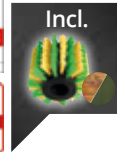
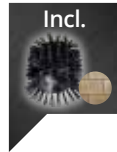

	PICOBELLA EXPERT	PICOBELLA EXPERT
PXC battery voltage / capacity	18 V / -	18 V / -
Max. working width	215 mm	215 mm
Diameter of brush	115 mm	115 mm
Idle speed	800 - 1400 min ⁻¹	800 - 1400 min ⁻¹
Product weight	4.1 kg	4.1 kg
Garden hose connection inclusive water control valve	•	•
Forward/reverse running	•	•
Electronic speed control	•	•
Brush change without tools	•	•
Telescopic long handle, infinitely adjustable	•	•
Height adjustable additional handle	•	•
Number of batteries / number of chargers	0 / 0	0 / 0
Incl. surface brush	MEDIUM (smooth stone, e.g. tiles and concrete)	SOFT (wood/WPC/BPC and artificial turf)
Nylon brush incl.	•	•
Incl. side brush	•	-
Article number	34.242.00	34.242.01



CORDLESS SURFACE BRUSHES ACCESSORIES



	Surface Brush SOFT	Surface Brush MEDIUM (incl. side brush)	Surface Brush ULTRA	Side Brush ULTRA
Material	Nylon	Nylon	Steel	Steel
Diameter of brush	115 mm	115 mm	115 mm	115 mm
Working width	195 mm	215 mm	195 mm	215 mm
Suitable for	wood, artificial turf	stone	stone (robust)	stone (robust)
Article number	34.241.21	34.241.20	34.241.22	34.241.26



PERFECT BRUSHES FOR EVERY SURFACE



Surface Brush SOFT

- Wood / WPC / BPC
- Artificial turf



Surface Brush MEDIUM

- Smooth stone e.g. tiles/concrete
- Incl. side brush for cleaning right to the wall and into edges

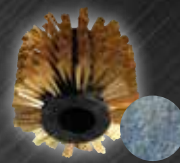

Surface Brush ULTRA

- Rough stone
- Robust stone e.g. granite/porphyry



Side Brush ULTRA

- Rough stone
- Robust stone e.g. granite/porphyry
- Incl. side brush for cleaning right to the wall and into edges

CORDLESS HEDGE TRIMMERS

SWIVELING REAR HANDLE

The rear handle can be swiveled: optimum handling – for vertical and horizontal cuts without fatigue

ERGONOMIC FRONT HANDLE

The slimline front handle with several micro switches makes it comfortable to work with

METAL GEARING

Rugged metal gearing for efficient power transmission and long product life

IMPACT GUARD

The impact guard protects the blades and the work area against damage

CUTTINGS COLLECTOR

Perfect removal of the cuttings from the top of the hedge when trimming hedges is ensured by the practical cuttings collector

ALUMINIUM COVER

The product comes complete with a sturdy aluminium cover for protecting the blades

HIGH QUALITY BLADES

The blades made of laser-cut and diamond ground steel are designed for maximum precision and durability

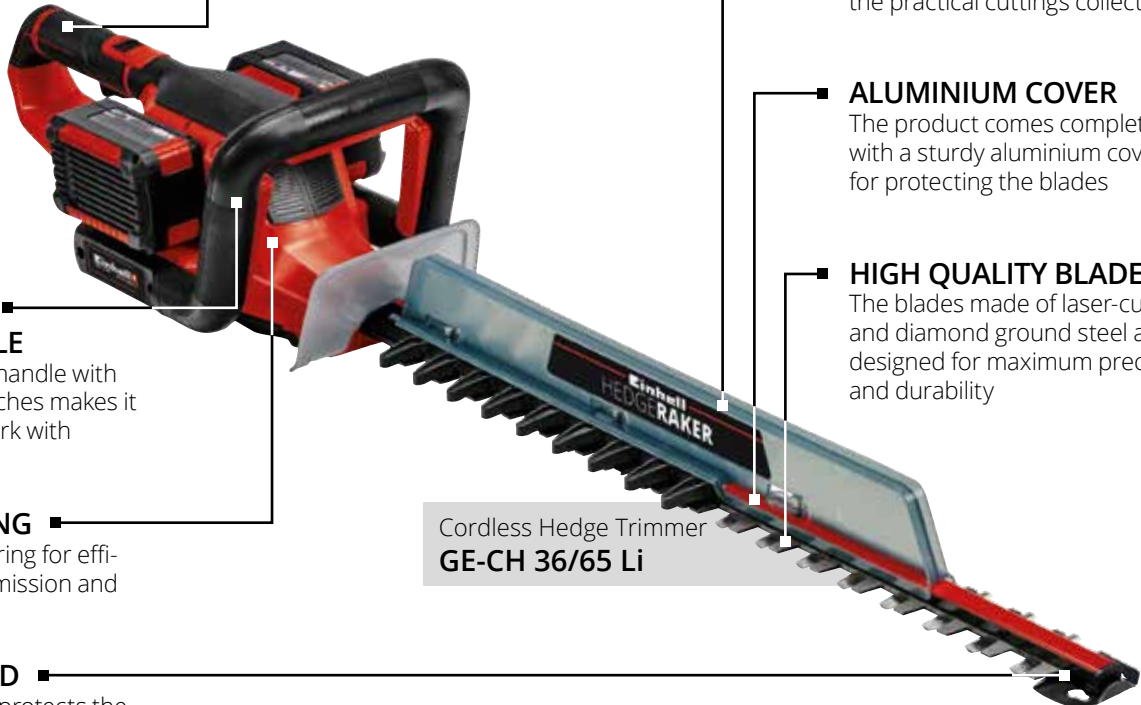

Cordless Hedge Trimmer
GE-CH 36/65 Li

CORDLESS HEDGE TRIMMERS

36 V POWER
2 x 18 V

LONG LASTING SHARPNESS
LASERCUT & DIAMOND GROUND



	GE-CH 36/65 Li - Solo EXPERT	GE-CH 36/61 Li - Solo EXPERT NEW
PXC battery voltage / capacity	2x 18 V / -	2x 18 V / -
Charging time	-	-
Max. running time	-	-
Bar length	720 mm	670 mm
Cutting length	650 mm	610 mm
Spacing between teeth	30 mm	26 mm
Product weight	4.0 kg	2.9 kg
Turnable rear handle	•	-
Ergonomic front handle thanks to micro switches	•	•
Cutting collector	•	•
Laser-cut and diamond-ground blades	•	•
Metal gear box	•	•
Soft grip	•	•
Aluminium cover over cutters	•	•
Number of batteries / number of chargers	0 / 0	0 / 0
Protective cover with wall mount	•	•
Article number	34.109.60	34.109.65



CORDLESS HEDGE TRIMMERS

LONG LASTING SHARPNESS

LASERCUT & DIAMOND GROUND



	GE-CH 18/60 Li - Solo EXPERT	ARCURRA 18/55 EXPERT
PXC battery voltage / capacity	18 V / -	18 V / -
Charging time	-	-
Max. running time	-	-
Bar length	670 mm	620 mm
Cutting length	600 mm	550 mm
Spacing between teeth	22 mm	18 mm
Product weight	2.8 kg	2.7 kg
Turnable rear handle	•	-
Ergonomic front handle thanks to micro switches	•	•
Cutting collector	•	•
Laser-cut and diamond-ground blades	•	•
Metal gear box	•	•
Soft grip	•	•
Aluminium cover over cutters	•	•
Number of batteries / number of chargers	0 / 0	0 / 0
Protective cover with wall mount	•	•
Article number	34.109.30	34.109.20



CORDLESS HEDGE TRIMMERS

LONG LASTING SHARPNESS

LASERCUT & DIAMOND GROUND



	GC-CH 1855/1 Li CLASSIC	GC-CH 1855/1 Li - Solo CLASSIC
PXC battery voltage / capacity	18 V / 2.5 Ah	18 V / -
Charging time	50 min	-
Max. running time	100 min	-
Bar length	620 mm	620 mm
Cutting length	550 mm	550 mm
Spacing between teeth	18 mm	18 mm
Product weight	2.4 kg	2.4 kg
Turnable rear handle	•	•
Ergonomic front handle thanks to micro switches	-	-
Cutting collector	•	•
Laser-cut and diamond-ground blades	•	•
Metal gear box	•	•
Soft grip	•	•
Aluminium cover over cutters	•	•
Number of batteries / number of chargers	0 / 0	0 / 0
Protective cover with wall mount	•	•
Article number	34.105.06	34.105.02



CORDLESS HEDGE TRIMMERS

LONG LASTING SHARPNESS

LASERCUT & DIAMOND GROUND



	GC-CH 1846 Li CLASSIC	GC-CH 1846 Li - Solo CLASSIC	GC-CH 18/40 Li - Solo CLASSIC NEW
PXC battery voltage / capacity	18 V / 2.0 Ah	18 V / -	18 V / -
Charging time	40 min	-	-
Max. running time	80 min	-	-
Bar length	520 mm	520 mm	475 mm
Cutting length	460 mm	460 mm	400 mm
Spacing between teeth	15 mm	15 mm	13 mm
Product weight	2.3 kg	2.0 kg	2.0 kg
Turnable rear handle	-	-	-
Ergonomic front handle thanks to micro switches	-	-	-
Cutting collector	-	-	-
Laser-cut and diamond-ground blades	•	•	•
Metal gear box	•	•	•
Soft grip	•	•	•
Aluminium cover over cutters	•	•	•
Number of batteries / number of chargers	1 / 1	0 / 0	0 / 0
Protective cover with wall mount	•	•	•
Article number	34.106.83	34.106.42	34.109.40



CORDLESS MULTIFUNCTIONAL TOOLS

4-IN-1

- MOWING
- TRIMMING
- PRUNING
- CUTTING

36 V

POWER
2 x 18 V

BRUSHLESS
ENERGY



GE-LM 36/4in1 - Solo	
EXPERT	
PXC battery voltage / capacity	2x 18 V / -
Bar length (chainsaw)	200 mm
Chain cutting speed	10 m/s
Blade length of hedge trimmer	450 mm
Spacing between teeth (hedge trimmer)	24 mm
Cutting width (blade)	255 mm
Cutting width (thread)	330 mm
Max. working height of elevated tools	3.5 m (pole-mounted pruner) / 3.5 m (hedge trimmer)
Product weight	9.0 kg (incl. all attachments)
Brushless motor	•
Telescopic aluminium handle with extension	•
Laser-cut and diamond-ground blades	•
Cutting unit (hedge trimmer) tiltable	•
OREGON quality bar and chain	•
Automatic chain lubrication	•
Automatic jog line feed	•
Adjustable second handle	•
Carrying belt with quick release	•
Number of batteries / number of chargers	0 / 0
Protective cover with wall mount	•
Article number	34.109.01



CORDLESS MULTIFUNCTIONAL TOOLS

FITTED WITH
OREGON
CHAIN AND BAR

LONG LASTING SHARPNESS
LASERCUT & DIAMOND GROUND

90°
ATTACHMENT PIVOTABLE - PATENTED



90°
ATTACHMENT PIVOTABLE - PATENTED



GE-HC 18 Li T	
EXPERT	
PXC battery voltage / capacity	18 V / 3.0 Ah
Charging time	60 min
Max. running time	40 min
Bar length (chainsaw)	200 mm
Chain cutting speed	3.76 m/s
Max. cutting length hedge trimmer	450 mm
Spacing between teeth (hedge trimmer)	16 mm
Max. working height	4.0 m (pole-mounted pruner) / 3.5 m (hedge trimmer)
Product weight	6.3 kg (incl. all attachments)
Continuously adjustable telescopic aluminium handle	•
Main handle + motor head tiltable by several settings	•
OREGON quality bar and chain	•
Toolless chain tensioning and changing	•
Pivotable attachment for effortless horizontal cuts	•
Automatic chain lubrication	•
Laser-cut and diamond-ground blades	•
Adjustable second handle	•
Number of batteries / number of chargers	1 / 1
Article number	34.108.05



GE-HC 18 Li T - Solo	
EXPERT	
PXC battery voltage / capacity	18 V / -
Charging time	-
Max. running time	-
Bar length (chainsaw)	200 mm
Chain cutting speed	3.76 m/s
Max. cutting length hedge trimmer	450 mm
Spacing between teeth (hedge trimmer)	16 mm
Max. working height	4.0 m (pole-mounted pruner) / 3.5 m (hedge trimmer)
Product weight	5.2 kg (incl. all attachments)
Continuously adjustable telescopic aluminium handle	•
Main handle + motor head tiltable by several settings	•
OREGON quality bar and chain	•
Toolless chain tensioning and changing	•
Pivotable attachment for effortless horizontal cuts	•
Automatic chain lubrication	•
Laser-cut and diamond-ground blades	•
Adjustable second handle	•
Number of batteries / number of chargers	0 / 0
Article number	34.108.00



CORDLESS POLE-MOUNTED PRUNERS

FITTED WITH
OREGON
CHAIN AND BAR



	GE-LC 18 Li T - Solo EXPERT	GC-LC 18/20 Li T - Solo CLASSIC
PXC battery voltage / capacity	18 V / -	18 V / -
Bar length	200 mm	200 mm
Cutting length	170 mm	195 mm
Cutting speed	3.76 m/s	5.5 m/s
Max. working height	4.0 m	4.0 m
Product weight	4.0 kg	3.4 kg
Continuously adjustable telescopic aluminium handle	•	-
Telescopic aluminium handle with extension	-	•
Main handle + motor head tiltable by several settings	•	-
OREGON quality bar and chain	•	•
Chain tensioning and changing	without tools	with tools
Pivotable attachment for effortless horizontal cuts	•	-
Automatic chain lubrication	•	•
Claw stop	•	•
Metal gear box	•	•
Adjustable second handle	•	-
Additional holding area	-	•
Number of batteries / number of chargers	0 / 0	0 / 0
Article number	34.108.10	34.105.81



CORDLESS POLE-MOUNTED PRUNERS ACCESSORIES



	Hedge Trimmer ACCESSORY
Can be used for	GE-LC 18 Li T
Product weight	1.4 kg
Article number	34.108.18



CORDLESS TELESCOPIC HEDGE TRIMMERS

LONG LASTING SHARPNESS

LASERCUT & DIAMOND GROUND



	GE-HH 18/45 Li T - Solo EXPERT	GC-HH 18/45 Li T - Solo CLASSIC
PXC battery voltage / capacity	18 V / -	18 V / -
Bar length	450 mm	450 mm
Cutting length	400 mm	410 mm
Spacing between teeth	16 mm	18 mm
Max. working height	3.5 m	3.5 m
Product weight	4.3 kg	3.5 kg
Continuously adjustable telescopic aluminium handle	•	-
Telescopic aluminium handle with extension	-	•
Motor head tiltable by multiple settings	•	•
Main handle tiltable by multiple settings	•	-
Laser-cut and diamond-ground blades	•	•
Metal gear box	•	•
Adjustable second handle	•	-
Swiveling main handle	-	•
Additional holding area	-	•
Number of batteries / number of chargers	0 / 0	0 / 0
Article number	34.108.66	34.105.85



CORDLESS TELESCOPIC HEDGE TRIMMERS ACCESSORIES

FITTED WITH
OREGON
CHAIN AND BAR



	Pole Pruner ACCESSORY
Can be used for	GE-HH 18/45 Li T
Product weight	1.2 kg
Article number	34.108.35



CORDLESS CHAINSAWS

TOP HANDLE

Positioning the main handle above the chainsaw results in an ideally balanced and compact saw that is perfectly suited for tree maintenance and branch removal

ERGONOMIC HANDLE

with soft grip

METAL STOP CLAW

The rugged metal stop claw keeps the saw stable for added safety and working comfort

KICKBACK PROTECTION WITH INSTANT CHAIN BRAKE

Kickback protection with instant reaction mechanical chain brake and large hand guard for safe operation

AUTOMATIC CHAIN LUBRICATION

For frictionless operation and a long service life

Top-Handled Cordless Chainsaw
FORTEXXA 18/20 TH*

TOOLLESS CHAIN TENSIONING AND CHANGING

User-friendly: Chain tensioning / changing and chainsaw adjustment without the need for additional tools

TIP GUARD

to reduce the risk of kickback. Cutting a branch from underneath is also made easier

TOP-HANDLED CORDLESS CHAINSAW



OREGON HIGH-QUALITY CHAIN AND BAR

OREGON chains and bars enable effortless sawing and perfect cutting results

MORE POWER AND LONGER OPERATING TIMES

The brushless motor guarantees both maximum power and longer operating times per battery charge on top of all the other advantages



	FORTEXXA 18/20 TH PROFESSIONAL NEW
PXC battery voltage / capacity	18 V / -
Bar length	200 mm
Cutting length	140 mm
Cutting speed	7 m/s
Oil tank capacity	75 ml
Product weight	2.5 kg
OREGON quality bar and chain	•
Toolless chain tensioning and changing	•
Automatic chain lubrication	•
Sturdy stop claws made of metal	•
Kickback protection with mechanical instant chain brake	•
Chain catch bolt	•
Soft grip	•
Large oil filler opening	•
Tip guard	•
Number of batteries / number of chargers	0 / 0
Protective cover	•
Article number	46.000.20



4 006825 663099

* WARNING: This chainsaw may only be used by trained tree care workers. Misactions in compliance with safety instructions may cause serious injuries.

CORDLESS CHAINSAWS



36 V
POWER
2 x 18 V

FITTED WITH
OREGON
CHAIN AND BAR



	GP-LC 36/35 Li - Solo PROFESSIONAL
PXC battery voltage / capacity	2x 18 V / -
Bar length	350 mm
Cutting length	330 mm
Cutting speed	15 m/s
Oil tank capacity	115 ml
Product weight	4.0 kg
OREGON quality bar and chain	•
Toolless chain tensioning and changing	•
Automatic chain lubrication	•
Sturdy stop claws made of metal	•
Kickback protection with mechanical instant chain brake	•
Chain catch bolt	•
Soft grip	•
Large oil filler opening	•
Number of batteries / number of chargers	0 / 0
Protective cover	•
Article number	45.017.80



CORDLESS CHAINSAWS



FITTED WITH
OREGON
CHAIN AND BAR



	FORTEXXA 18/30 EXPERT NEW	GE-LC 18/25 Li EXPERT	GE-LC 18/25 Li - Solo EXPERT
PXC battery voltage / capacity	18 V / -	18 V / 3.0 Ah	18 V / -
Charging time	-	60 min	-
Max. running time	-	100 cuts / 70 x 70 mm timber	-
Bar length	300 mm	250 mm	250 mm
Cutting length	270 mm	230 mm	230 mm
Cutting speed	8.9 / 6 m/s	4.5 m/s	4.5 m/s
Oil tank capacity	160 ml	200 ml	200 ml
Product weight	4.1 kg	3.0 kg	2.9 kg
OREGON quality bar and chain	•	•	•
Toolless chain tensioning and changing	•	•	•
Automatic chain lubrication	•	•	•
Adjustable chain speed (High/Eco)	•	-	-
Sturdy stop claws made of metal	•	•	•
Kickback protection with mechanical instant chain brake	•	•	•
Chain catch bolt	•	•	•
Soft grip	•	•	•
Large oil filler opening	•	•	•
Number of batteries / number of chargers	0 / 0	1 / 1	0 / 0
Protective cover	•	•	•
Article number	46.000.10	45.017.60	45.017.61



CORDLESS CHAIN SHARPENER



	GE-CS 18 Li - Solo EXPERT
PXC battery voltage / capacity	18 V / -
Grinding wheel diameter (inside)	23 mm
Grinding wheel diameter (outside)	108 mm
Grinding wheel thickness	3.2 mm
Product weight	1.7 kg
Depth stop	•
Scale for precise setting of the grinding angle	•
LED light	•
Clamping device	•
Number of batteries / number of chargers	0 / 0
Article number	44.999.40



CORDLESS LEAF BLOWERS

MORE POWER AND LONGER OPERATING TIMES

The brushless motor guarantees both maximum power and longer operating times per battery charge on top of all the other advantages



ADJUSTABLE, REMOVABLE TUBE

Thanks to the toolless change of length, the item can be adjusted perfectly to every body height and be stored spacesaving

ROBUST METAL RING

The tube end is protected from damage by a robust metal ring to extend its lifetime

Cordless Leaf Blower
GP-LB 36/210 Li E

TURBO SWITCH

It ensures a maximum blowing volume to enable, e.g. damp leaves to be effortlessly shifted as well

ELECTRONIC SPEED CONTROL

The right rotational speed for every application

INCL. SHOULDER STRAP

The integrated shoulder strap with shoulder pad makes it particularly comfortable to work with and takes the strain off the user

CORDLESS LEAF BLOWERS



GP-LB 36/210 Li E - Solo	
PROFESSIONAL	
PXC battery voltage / capacity	2x 18 V / -
Charging time	-
Max. running time	-
Max. blowing velocity	210 km/h
Max. blowing air flow	816 m³/h
Idle speed	10000 - 22300 min ⁻¹
Product weight	2.5 kg
Brushless motor	•
Turbo function	•
Electronic speed control	•
Carrying strap	•
Soft grip	•
Number of batteries / number of chargers	0 / 0
Article number	34.336.20



4 006825 638967

CORDLESS LEAF BLOWERS



	GP-LB 18/200 Li GK - Solo PROFESSIONAL NEW	GP-LB 18/200 Li E - Solo PROFESSIONAL NEW
PXC battery voltage / capacity	18 V / -	18 V / -
Charging time	-	-
Max. running time	-	-
Max. blow velocity	200 km/h	200 km/h
Max. blowing air flow	670 m ³ /h	670 m ³ /h
Idle speed	13000 - 18000 min ⁻¹	13000 - 18000 min ⁻¹
Product weight	2.16 kg	2.16 kg
Brushless motor	•	•
Turbo function	•	•
Electronic speed control	•	•
Carrying strap	-	-
Soft grip	•	•
Gutter cleaning set	•	- (available as an accessory)
Number of batteries / number of chargers	0 / 0	0 / 0
Article number	34.335.50	34.335.55



CORDLESS LEAF BLOWERS



RECOMMENDED PRICE 1,4



	GC-CL 18 Li E Kit (1x 2.0 Ah) CLASSIC	GC-CL 18 Li E - Solo CLASSIC
PXC battery voltage / capacity	18 V / 2.0 Ah	18 V / -
Charging time	40 min	-
Max. running time	14 - 240 min	-
Max. blow velocity	210 km/h	210 km/h
Max. blowing air flow	105 m³/h	105 m³/h
Idle speed	1400 - 12000 min ⁻¹	1400 - 12000 min ⁻¹
Product weight	1.7 kg	1.3 kg
2-parts tube	-	-
Brushless motor	-	-
Electronic speed control	•	•
Carrying strap	-	-
Soft grip	•	•
Number of batteries / number of chargers	1 / 1	0 / 0
Article number	34.335.33	34.335.32



CORDLESS UNIVERSAL BLOWERS

AUTUMN 2022



Illustration similar



	GE-UB 18/250 Li E - Solo EXPERT NEW	GC-CL 18/1 Li E - Solo CLASSIC
PXC battery voltage / capacity	18 V / -	18 V / -
Charging time	-	-
Max. running time	-	-
Max. blow velocity	250 km/h	210 km/h
Max. blowing air flow	120 m³/h	105 m³/h
Idle speed	16000 - 18500 min ⁻¹	1400 - 12000 min ⁻¹
Product weight	1.1 kg	1.3 kg
2-parts tube	•	•
Brushless motor	-	-
Electronic speed control	• (LED)	•
Carrying strap	-	-
Soft grip	•	•
Number of batteries / number of chargers	0 / 0	0 / 0
Article number	34.335.42	34.335.41



CORDLESS LEAF VACUUMS

ELECTRONIC SPEED CONTROL WITH TURBO SWITCH

Set the blow and suction velocity to match every purpose. Turbo switch with maximum power for damp leaves. The practical LED display indicates the level selected

QUICK FASTENING SYSTEM

Clever click-in fastening of the debris bag makes for easy emptying

BRUSHLESS MOTOR

Efficient, long-lasting and powerful

SHREDDING WHEEL WITH CLEANING OPENING

Effortless access to the impeller wheel in order to remove any residues

TOOLLESS CHANGE-OVER

Quick changing over between vacuum and blowing function easily without any tools

WALL HOLDER

Integrated wall mount for space-saving storage

Cordless Leaf Vacuum
VENTURRO 36/240



Illustration similar

HIGH-QUALITY DEBRIS BAG

Big debris bag with window for level inspection

GUIDING WHEELS (HEIGHT-ADJUSTABLE)

Large, robust wheels provide optimum weight relief and stability even on rugged terrain

CORDLESS LEAF VACUUMS



Illustration similar

**36 V
POWER
2 x 18 V**

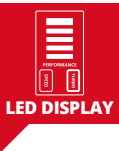

INCL. CARRYING STRAP

The integrated carrying strap makes it particularly comfortable to work with and takes the strain off the user

MORE POWER AND LONGER OPERATING TIMES

The brushless motor guarantees both maximum power and longer operating times per battery charge on top of all the other advantages



	VENTURRO 36/240 PROFESSIONAL	NEW
PXC battery voltage / capacity	2x 18 V / -	
Max. blow velocity	240 km/h	
Max. suction power	740 m³/h	
Idle speed	8000 - 13000 min ⁻¹	
Shredding function	10:1	
Debris bag volume	45 l	
Product weight	4.0 kg	
Toolless change-over between suction and blasting function	•	
Brushless motor	•	
Turbo function	•	
Electronic speed control	•	
Additional handle	•	
Cleaning opening with safety switch	•	
Guiding wheels	• (height adjustable)	
Debris bag with window	•	
Carrying strap	•	
Soft grip	•	
Number of batteries / number of chargers	0 / 0	
Article number	34.336.40	



4 006825 665451

CORDLESS LEAF VACUUMS

**36 V
POWER
2 x 18 V**



	GE-CL 36 Li E - Solo EXPERT	GE-CL 36/230 Li E - Solo EXPERT
PXC battery voltage / capacity	2x 18 V / -	2x 18 V / -
Max. blow velocity	210 km/h	230 km/h
Max. suction power	720 m³/h	700 m³/h
Idle speed	8000 - 13000 min ⁻¹	8000 - 14000 min ⁻¹
Shredding function	10:1	10:1
Debris bag volume	45 l	45 l
Product weight	3.4 kg	3.1 kg (blow) / 4.4 kg (vacuum)
Toolless change-over between suction and blasting function	•	•
Brushless motor	•	-
Turbo function	-	•
Electronic speed control	•	•
Additional handle	• (adjustable)	• (adjustable)
Cleaning opening with safety switch	-	•
Guiding wheels	•	• (height adjustable)
Debris bag with window	•	•
Carrying strap	•	•
Soft grip	•	•
Number of batteries / number of chargers	0 / 0	0 / 0
Article number	34.336.00	34.336.30



CORDLESS LEAF VACUUMS



**AUTUMN
2022**

**LOW WEIGHT
EASY HANDLING**

**AIR SPEED
MIN - MAX**

Illustration similar

	VENTURRO 18/210 EXPERT	NEW
PXC battery voltage / capacity	18 V / -	
Max. blow velocity	210 km/h	
Max. suction power	500 m³/h	
Idle speed	8000 - 14000 min ⁻¹	
Shredding function	10:1	
Debris bag volume	45 l	
Product weight	3.0 kg	
Toolless change-over between suction and blasting function	•	
Brushless motor	•	
Turbo function	-	
Electronic speed control	•	
Additional handle	•	
Cleaning opening with safety switch	-	
Guiding wheels	•	
Debris bag with window	•	
Carrying strap	•	
Soft grip	•	
Number of batteries / number of chargers	0 / 0	
Article number	34.336.25	



CORDLESS GRASS AND SHRUB SHEARS

LONG LASTING SHARPNESS

LASERCUT & DIAMOND GROUND



	GE-CG 18/100 Li T - Solo EXPERT	GE-CG 18/100 Li - Solo EXPERT
PXC battery voltage / capacity	18 V / -	18 V / -
Cutting width with grass shear blade	100 mm	100 mm
Cutting length with shrub cutting blade	200 mm	200 mm
Spacing between teeth of shrub cutting blade	8 mm	8 mm
Product weight	1.6 kg	0.8 kg
Blade change without tools	•	•
Laser-cut blades	•	•
Metal gear box	-	-
Covered gearbox	•	•
Soft grip	•	•
Telescopic handle	•	-
Number of batteries / number of chargers	0 / 0	0 / 0
Article number	34.103.10	34.103.13



4 006825 652109



4 006825 652710

CORDLESS GRASS AND SHRUB SHEARS

LONG LASTING SHARPNESS

LASERCUT & DIAMOND GROUND



	GC-CG 18 Li - Solo CLASSIC	GC-CG 18/1 Li - Solo CLASSIC
PXC battery voltage / capacity	18 V / -	18 V / -
Cutting width with grass shear blade	100 mm	100 mm
Cutting length with shrub cutting blade	200 mm	-
Spacing between teeth of shrub cutting blade	8 mm	-
Product weight	0.7 kg	0.7 kg
Blade change without tools	•	•
Laser-cut blades	•	•
Metal gear box	•	•
Covered gearbox	-	-
Soft grip	•	•
Telescopic handle	-	-
Number of batteries / number of chargers	0 / 0	0 / 0
Article number	34.103.70	34.103.82



4 006825 614213



4 006825 654875

CORDLESS PRUNING SAW



	GE-GS 18 Li - Solo EXPERT PLUS
PXC battery voltage / capacity	18 V / -
Saw blade length	150 mm
Cutting capacity with branch handle	70 mm
Cutting capacity without branch handle	90 mm
Product weight	1.1 kg
kwb high-quality saw blade	•
Blade change without tools	•
Removable branch handle	•
Soft grip	•
Long-life metal gearing	•
Number of batteries / number of chargers	0 / 0
Article number	34.082.20



CORDLESS PRUNING SHEARS



	GE-LS 18 Li - Solo EXPERT
PXC battery voltage / capacity	18 V / -
Max. branch diameter	28 mm
Product weight	0.9 kg
Bypass blades	•
Belt clip	•
ON/OFF sliding switch	•
Sturdy plastic cover	•
Ergonomic handle with soft grip	•
Number of batteries / number of chargers	0 / 0
Article number	34.083.00



CORDLESS PRESSURE SPRAYERS



	GE-WS 18/150 Li - Solo EXPERT	GE-WS 18/75 Li - Solo EXPERT	GE-WS 18/35 Li - Solo EXPERT
PXC battery voltage / capacity	18 V / -	18 V / -	18 V / -
Filling capacity of the tank	15 l	7.5 l	3.5 l
Max. spraying pressure	4.5 bar	2.5 bar	2.5 bar
Pressure hose length	1400 mm	1400 mm	1400 mm
Max. liquid temperature	40°C	40°C	40°C
Product weight	4.7 kg	2.4 kg	2.2 kg
Automatic pump, no manual pressure build-up required	•	•	•
Transparent tank with scale for checking the level	•	•	•
Individually adjustable brass nozzle	•	•	•
Telescopic lance made of stainless steel	-	•	•
Battery cover – provides protection against water ingress	•	•	•
Spray lance with lockable operating button	•	•	•
Large filler opening	•	•	•
Padded carrying strap	•	•	•
Number of batteries / number of chargers	0 / 0	0 / 0	0 / 0
Article number	34.252.30	34.252.20	34.252.10



4 006825 651362



4 006825 646368



4 006825 645774

CORDLESS PRESSURE SPRAYERS ACCESSORIES



	Sprayer Accessory Kit NEW
Telescopic spray lance	1 - 2 m
Product weight	0.25 kg
Telescopic lance made of stainless steel	•
Plastic spray bell	•
Article number	34.252.05



4 006825 664003

	Tank 7.5 litres NEW
Filling capacity of the tank	7.5 l
Product weight	0.8 kg
Transparent tank with scale for checking the level	•
Large metal clip on the tank for opening and closing easily	•
Article number	34.252.06



4 006825 664065

BATTERY BELT

MULTI-FUNCTIONAL:
FOR 36 V
AND FOR 18 V
DEVICES



	GE-PB 36/18 Li EXPERT NEW
PXC battery voltage / capacity	Suitable for 18 V appliances and 36 V (2x 18 V) appliances
Number of battery pockets	2 pcs
Cable length	150 cm
Length of hip belt	150 cm
Product weight	1.8 kg
Padded carrying strap	•
Large buckle for easy opening and closing	•
Cable hook	•
Second battery pocket removable	•
Number of batteries / number of chargers	0 / 0
Article number	34.083.10



CORDLESS HOT AIR GENERATOR



	GE-HG 18/370 Niro Li - Solo EXPERT PLUS
PXC battery voltage / capacity	18 V / -
Heating output	37 kW
Hot air flow	1000 m ³ /h
Max. gas consumption	2693 g/h
Max. operating pressure	1.5 bar
Gas bottle	5 kg - 11 kg propane-butane
Gas type	Propane, butane or propane-butane-mixtures
Product weight	4.65 kg
Housing made of stainless steel	•
Heating jacket made of galvanized steel sheet	•
Piezo ignition	•
On/Off switch for fan	•
Backfire guard + piezo-electric flame guard	•
Solenoid valve + gas valve button	•
Only for use in	Germany + Austria
Number of batteries / number of chargers	0 / 0
Accessories	Pressure regulator 1500 mbar + gas hose
Article number	23.308.05



CORDLESS GARDEN PUMP

2-STEP ECO SWITCH

2 power levels:
BOOST: Full delivery pressure with full delivery rate
ECO: Same delivery rate with reduced delivery pressure, so double the battery operating time

CONNECTIONS WITH METAL THREADS

Thread made of high-quality metal for a long service life for the thread and pump

CARRY HANDLE

For great mobility and flexibility

Cordless Garden Pump
AQUINNA 36/30

FROST PROTECTION

Water drain screw for draining residual water easily and for frost protection

SPLASH GUARD COVER

Protects the batteries against splash water

CORDLESS GARDEN PUMP

36 V
POWER
 2 x 18 V



AQUINNA 36/30	
EXPERT	
PXC battery voltage / capacity	2x 18 V / -
Max. delivery capacity / height	3000 l/h / 26 m
Max. suction height	8 m
Suction connection	42 mm (1 1/4") ET
Pressure connection	33.3 mm (1") IT
Product weight	3.3 kg
Water filler screw	•
Water drain screw	•
2-step ECO switch	•
Carry handle	•
Number of batteries / number of chargers	0 / 0
Incl. adapter 33.3 mm (1") ET	•
Article number	41.804.00



CORDLESS CLEAR WATER PUMPS



2-IN-1
SUBMERSIBLE
PRESSURE PUMP
+
RAIN BARREL
PUMP

2-IN-1 PUMP

The long cable connection means the GE-PP 18 RB Li can be used as a **submersible pressure pump**, e.g. in a cistern, and with the adjustable connection pipe as a **rain barrel pump**

BATTERY OPERATION

Garden watering without a socket – powerful yet independent

BATTERY BOX

Flexible battery box with integrated cable storage holder and miscellaneous fastening options

CONNECTION PIPE

Infinitely telescopic with practical holder and movable hose connection for individual positioning of the garden hose

Cordless Clear Water Pump
GE-PP 18 RB Li

LONG CABLE CONNECTION

Long cable connection for greater immersion depth

POWERFUL MOTOR

This generates a high delivery pressure of over 2 bar, enabling easy operation of the lawn sprinkler and garden spray gun

STABLE HOUSING

High-quality pump housing made of impact-resistant plastic



CORDLESS CLEAR WATER PUMPS



GE-PP 18 RB Li - Solo	
EXPERT	
PXC battery voltage / capacity	18 V / -
Max. delivery capacity / height	3000 l/h / 20 m
Max. immersion depth	4 m
Hose connection	33.3 mm (1") ET
Power cord	5 m
Product weight excl. / incl. accessories	2.5 / 3.1 kg
Mobile battery box	•
Integrated cable rewind	•
Integrated wall mount	•
Suspension device made from stainless steel	•
Telescopic extension tube	•
Flexible gooseneck	•
Number of batteries / number of chargers	0 / 0
Article number	41.704.29



4 006825 651270

CORDLESS CLEAR WATER PUMPS



	GE-SP 18 LL Li - Solo
	EXPERT NEW
PXC battery voltage / capacity	18 V / -
Max. delivery capacity / height	4500 l/h / 8 m
Max. immersion depth	4 m
Hose connection	33.3 mm (1") ET
Power cord	5 m
Product weight excl. / incl. accessories	2.3 / 2.3 kg
Mobile battery box	•
Dry running protection	•
Integrated cable rewind	•
Integrated wall mount	•
Suspension device made from stainless steel	•
Telescopic extension tube	-
Flexible gooseneck	-
Low level suction down to 1 mm	•
Number of batteries / number of chargers	0 / 0
Article number	41.815.60



4 006825 661415

CORDLESS CLEAR WATER PUMPS



	GE-SP 18 Li - Solo
	EXPERT
PXC battery voltage / capacity	18 V / -
Max. delivery capacity / height	5000 l/h / 8 m
Max. immersion depth	4 m
Suction down to	15 mm
Hose connection	33.3 mm (1") ET
Power cord	5 m
Product weight excl. / incl. accessories	2.6 / 2.7 kg
Mobile battery box	•
Dry running protection	•
Integrated cable rewind	•
Integrated wall mount	•
Suspension device made from stainless steel	•
Telescopic extension tube	-
Flexible gooseneck	-
Number of batteries / number of chargers	0 / 0
Article number	41.815.00



4 006825 651379



SYSTEM CASES E-CASE

E-CASE-SYSTEM

CAN BE EQUIPPED WITH PADLOCK
To guard against theft, the E-Case can be equipped with a padlock

LOCKING SYSTEM
The locking system for connecting stacked cases ensures easy storage and transport

SPLASH-PROOF DESIGN
E-Cases are designed to keep out not only splash water but also dirt and dust in order to protect tools and accessories

HIGH-QUALITY MATERIAL
The E-Case is made of polypropylene. That ensures heat resistance, stiffness and impact resistance

COMPATIBILITY
All E-Case sizes are mutually compatible and interconnectable

LABEL STICKER
So that you always know what's in the case

STURDY FASTENERS
for closing the case securely

FOLD-IN HANDLES
Carrying the case is comfortable thanks to two fold-in and ergonomic handles – one on the top and one on the side

System Case
E-CASE S-F

FOUR DEPRESSIONS IN THE LID
to prevent stacked cases from slipping

OPTIONAL – PLASTIC COMPARTMENTS
Maximum flexibility for storing and transporting accessories such as screws, bits, etc.

EASY STORAGE AND TRANSPORTATION



WIDE RANGE OF APPLICATIONS



Art. N° 45.400.11



Art. N° 45.400.1 in combination with
Art. N° 45.400.12



Art. N° 45.400.11 in combination with
Art. N° 45.400.13

SYSTEM CASES E-CASE



	E-Case S-F	E-Case L NEW	E-Case Tower NEW
Items supplied	1x system case + 2x foam inserts for devices	1x E-Case L + 1x hand tool insert	1x E-Case S + 2x foam inlays, 1x E-Case S + 1x set of plastic compartments, 1x E-Case L + 1x hand tool insert, 9x plastic dividers
Internal dimensions	421 x 281 x 96 mm	421 x 273 x 320 mm	421 x 281 x 96 mm (E-Case S), 421 x 273 x 320 mm (E-Case L)
External dimensions	444 x 330 x 131 mm	444 x 410 x 360 mm	444 x 410 x 620 mm
Load capacity	25 kg	100 kg	100 kg
Product weight	1.7 kg	7.62 kg	11.4 kg
Stackable + locking system	•	•	•
Splash-proof	•	•	•
Lockable	•	•	•
Telescopic handle + wheels	-	•	•
Foam inserts	1x inlay for lid, 1x inlay for base	-	1x inlay for lid, 1x inlay for base
Plastic compartments	-	-	2x long, 3x mid-length, 4x short dividers
Hand tool insert	-	•	•
Article number	45.400.11	45.400.14	45.400.15



E-CASES ACCESSORIES



	Set of Plastic Compartments	Perforated Foam NEW
Suitable for	E-Case S-F	E-Case S-F
Items supplied	2x long, 3x medium, 4x short dividers	1x adjustable perforated foam inlay
Article number	45.400.12	45.400.13



UNMATCHED FOR RUGGEDNESS!



25 kg

Maximum loading of a single case when carried by the handle on the side



90 kg

Maximum loading of several cases when carried by the broad handle on the top



300 kg

Concentrated loading from above – withstands the weight of one person without difficulty



1000 kg

Maximum permissible loading of the case at the bottom of the stack

ACCESSORIES – BATTERIES

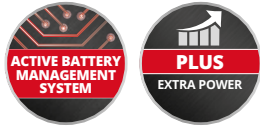

Illustration similar



	5-8 Ah Multi-Ah Power X-Change Plus Battery NEW	4-6 Ah Multi-Ah Power X-Change Plus Battery
Items supplied	1 battery	1 battery
PXC battery voltage / capacity	18 V / 8.0 Ah or 5.0 Ah (depending on the application)	18 V / 6.0 Ah or 4.0 Ah (depending on the application)
Battery power	max. 1350 W	max. 1350 W
Product weight	1.04 kg	1.02 kg
Article number	45.116.00	45.115.02



ACCESSORIES – BATTERIES

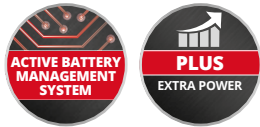

	5.2 Ah Power X-Change Plus Battery	4.0 Ah Power X-Change Plus Battery NEW	3.0 Ah Power X-Change Plus Battery
Items supplied	1 battery	1 battery	1 battery
PXC battery voltage / capacity	18 V / 5.2 Ah	18 V / 4.0 Ah	18 V / 3.0 Ah
Battery power	max. 1260 W	max. 900 W	max. 900 W
Product weight	0.89 kg	0.58 kg	0.57 kg
Article number	45.114.37	45.115.53	45.115.01



4-6 AH MULTI-AH POWER X-CHANGE PLUS BATTERY

Thanks to MULTI-Ah technology, switching over from a 4 Ah battery to a 6 Ah battery is really easy and can be done with just the push of a button. The 4 Ah battery has a 3x longer total service life and is suitable for lighter applications (e.g. cordless lamp or cordless screwdriver). The 6 Ah battery offers the maximum running time for more capacity-intensive applications (e.g. cordless lawn mower or cordless wet and dry vacuum cleaners).

4 Ah ► **300%** more lifetime ¹⁾

6 Ah ► **50%** more runtime ²⁾

¹⁾ in comparison to every standard lithium-ion battery
²⁾ in comparison to the 4.0 Ah battery

ACCESSORIES – BATTERIES



	4.0 Ah Power X-Change Battery	2.5 Ah Power X-Change Battery NEW	2.0 Ah Power X-Change Battery
Items supplied	1 battery	1 battery	1 battery
PXC battery voltage / capacity	18 V / 4.0 Ah	18 V / 2.5 Ah	18 V / 2.0 Ah
Battery power	max. 900 W	max. 720 W	max. 450 W
Product weight	0.65 kg	0.46 kg	0.40 kg
Article number	45.113.96	45.115.16	45.113.95



ACCESSORIES – BATTERIES



	2x 5.2 Ah Power X-Change Twin Pack	2x 4.0 Ah Power X-Change Twin Pack	2x 2.5 Ah Power X-Change Twin Pack NEW
Items supplied	2 batteries	2 batteries	2 batteries
PXC battery voltage / capacity	2x 18 V / 5.2 Ah	2x 18 V / 4.0 Ah	2x 18 V / 2.5 Ah
Battery power	max. 2x 1260 W	max. 2x 900 W	max. 2x 720 W
Product weight	1.78 kg	1.32 kg	0.92 kg
Article number	45.115.26	45.114.89	45.115.24



ACCESSORIES



	Battery Mounting Gadget
Items supplied	2 battery mounting gadgets, 4 screws, 4 dowels
Can be used for	18 V Power X-Change batteries
Article number	45.141.55



ACCESSORIES – CHARGERS



	2x2 Power X-Quattro Charger 4 A NEW	Power X-Boost Charger 6 A
Items supplied	1 charger	1 charger
Can be used for	18 V Power X-Change batteries	18 V Power X-Change batteries
Charging current	4 A	3 - 6 A
Multiple-port charger	• 4 charging slots allow 2 batteries to be charged at the same time	-
Boost mode	-	•
Integrated wall mount	-	•
Mains voltage	220 - 240 V ~ 50-60 Hz	220 - 240 V ~ 50-60 Hz
Article number	45.121.02	45.120.64



ACCESSORIES – CHARGERS



	Power X-Twincharger 3 A	Power X-Fastcharger 4 A
Items supplied	1 charger	1 charger
Can be used for	18 V Power X-Change batteries	18 V Power X-Change batteries
Charging current	3 A	4 A
Multiple-port charger	• 2 charging slots allow 2 batteries to be charged at the same time	-
Boost mode	-	-
Integrated wall mount	•	•
Mains voltage	220 - 240 V ~ 50-60 Hz	220 - 240 V ~ 50-60 Hz
Article number	45.120.69	45.121.03



**OUT-AND-ABOUT AND NO POWER SOCKET AVAILABLE?
NO PROBLEM
THANKS TO EINHELL!**



	Power X-Car Charger 3 A NEW
Items supplied	1 charger
Can be used for	18 V Power X-Change batteries
Charging current	3 A
Multiple-port charger	-
Boost mode	-
Integrated wall mount	•
Operating voltage	12 V DC
Article number	45.121.13



ACCESSORIES – STARTER KITS



	2x 3.0 Ah PXC Twincharger Starter Kit	2x 4.0 Ah PXC Twincharger Starter Kit NEW
Items supplied	2 batteries + 1 Twin Charger	2 batteries + 1 Twin Charger
PXC battery voltage / capacity	2x 18 V / 2x 3.0 Ah	2x 18 V / 2x 4.0 Ah
Battery power	max. 2x 900 W	max. 2x 900 W
Charging current	3 A	3 A
Mains voltage	220 - 240 V ~ 50-60 Hz	220 - 240 V ~ 50-60 Hz
Multiple-port charger	• 2 charging slots allow 2 batteries to be charged at the same time	• 2 charging slots allow 2 batteries to be charged at the same time
Boost mode	-	-
Integrated wall mount	•	•
Article number	45.120.83	45.121.12



ACCESSORIES – STARTER KITS



	5.2 Ah PXC Fastcharger Starter Kit	4.0 Ah Power X-Change Starter Kit	2.5 Ah Power X-Change Starter Kit
Items supplied	1 battery + 1 Power X-Fastcharger 4 A	1 battery + 1 Power X-Charger 3 A	1 battery + 1 Power X-Charger 3 A
PXC battery voltage / capacity	18 V / 5.2 Ah	18 V / 4.0 Ah	18 V / 2.5 Ah
Battery power	max. 1260 W	max. 900 W	max. 720 W
Charging current	4 A	3 A	3 A
Mains voltage	220 - 240 V ~ 50-60 Hz	220 - 240 V ~ 50-60 Hz	220 - 240 V ~ 50-60 Hz
Multiple-port charger	-	-	-
Boost mode	-	-	-
Integrated wall mount	•	•	•
Article number	45.121.14	45.120.42	45.120.97



EVEN MORE FREEDOM WITH POWER X-CHANGE. E-KICKSCOOTER ELMOTO KICK FROM GOVECS.

Einhell opens up its Power X-Change rechargeable battery platform! Together with E-Scooter manufacturer GOVECS, Einhell is helping to get ELMOTO KICK on the road, a road-legal E-Kickscooter with Power X-Change batteries.

With the new E-Kickscooter ELMOTO KICK from GOVECS, emissions-free scooting means you can leave your car at home or park slightly further away and simply jump on the scooter for the last mile.

ELMOTO KICK



- Approval for road use
- 36 V
- V max.: 20 km/h
- Max. range: up to 20 km
- 2 hydraulic disc brakes
- Pneumatic tyres (10")
- Folding handlebar

Article only available without batteries / chargers

Art. Nr. 48.500.61

NEW

The ELMOTO KICK is available in three colors:



THE BATTERY GUIDE – IT'S WHAT YOU NEED THAT MATTERS.

			18 V 2.0 Ah	18 V 2.5 Ah	18 V 3.0 Ah	18 V 4.0 Ah	18 V 5.2 Ah	18 V 6.0 Ah	18 V 8.0 Ah
Petrol Lawn Mower (PXC electric start)	GC-PM 46 SM HW-E Li		193 starts	242 starts	290 starts	386 starts	502 starts	580 starts	772 starts
Cordless Lawn Mowers	GP-CM 36/47 S HW Li		175 m ² 350 m ²	215 m ² 430 m ²	250 m ² 500 m ²	350 m ² 700 m ²	500 m ² 1000 m ²	600 m ² 1200 m ²	700 m ² 1400 m ²
	GE-CM 36/48 Li M		250 m ² 500 m ²	260 m ² 520 m ²	300 m ² 600 m ²	500 m ² 1000 m ²	600 m ² 1200 m ²	700 m ² 1400 m ²	1000 m ² 2000 m ²
	GE-CM 43 Li M		300 m ²	350 m ²	450 m ²	600 m ²	750 m ²	900 m ²	1200 m ²
	GE-CM 36/43 Li M		300 m ²	350 m ²	450 m ²	600 m ²	750 m ²	900 m ²	1200 m ²
	RASARRO 36/42		300 m ²	350 m ²	450 m ²	550 m ²	725 m ²	875 m ²	1100 m ²
	GP-CM 36/41 Li		280 m ²	330 m ²	425 m ²	500 m ²	700 m ²	850 m ²	1000 m ²
	RASARRO 36/38		300 m ²	330 m ²	400 m ²	450 m ²	700 m ²	800 m ²	900 m ²
	GE-CM 36/37 Li		250 m ²	290 m ²	400 m ²	450 m ²	650 m ²	800 m ²	900 m ²
	GE-CM 36/36 Li		240 m ²	270 m ²	350 m ²	400 m ²	600 m ²	700 m ²	960 m ²
	GE-CM 36/34-1 Li		200 m ²	250 m ²	300 m ²	400 m ²	500 m ²	600 m ²	800 m ²
	GE-CM 36/33 Li		200 m ²	250 m ²	300 m ²	400 m ²	500 m ²	600 m ²	800 m ²
	GE-CM 18/33 Li		100 m ²	140 m ²	180 m ²	250 m ²	300 m ²	350 m ²	500 m ²
	GE-CM 18/32 Li		300 m ²	140 m ²	180 m ²	250 m ²	300 m ²	350 m ²	500 m ²
	GE-CM 18/30 Li		70 m ²	100 m ²	150 m ²	210 m ²	270 m ²	300 m ²	420 m ²
	Cordless Push Reel Mower	GE-HM 18/38 Li		150 m ²	190 m ²	250 m ²	300 m ²	400 m ²	450 m ²
Cordless Universal Spreader	GE-US 18 Li		3 h	4 h	6 h	7 h	9 h	10 h	14 h
Cordless Scarifiers/Aerators	GE-SC 35/1 Li		150 m ²	190 m ²	225 m ²	300 m ²	400 m ²	-	-
	GC-SC 36/31 Li		100 m ²	130 m ²	200 m ²	250 m ²	300 m ²	350 m ²	500 m ²
	GC-SC 18/28 Li		80 m ²	100 m ²	120 m ²	160 m ²	210 m ²	240 m ²	350 m ²
Cordless Tillers	GE-CR 30 Li		20 min	21 min	25 min	35 min	50 min	60 min	70 min
	GE-CR 18/20 Li		25-35 min	30-40 min	40-50 min	50-70 min	70-90 min	80-100 min	100-140 min
Cordless Earth Auger	GP-EA 18/150 Li Brushless		15 pcs	20 pcs	30 pcs	40 pcs	50 pcs	60 pcs	80 pcs
Cordless Snow Thrower	GE-ST 36/40 Li E		20 min	25 min	30 min	40 min	50 min	60 min	80 min
Cordless Scythes	AGILLO 36/255 BL		30 min 25 min	35 min 28 min	45 min 35 min	65 min 45 min	80 min 60 min	90 min 70 min	130 min 90 min
	AGILLO 18/200		20 min 12 min	25 min 15 min	35 min 20 min	50 min 30 min	65 min 45 min	75 min 55 min	100 min 60 min



			18 V 2.0 Ah	18 V 2.5 Ah	18 V 3.0 Ah	18 V 4.0 Ah	18 V 5.2 Ah	18 V 6.0 Ah	18 V 8.0 Ah
Cordless Lawn Trimmers	GE-CT 36/30 Li E		30 min	38 min	45 min	60 min	75 min	90 min	120 min
	GE-CT 18/30 Li		30 min	38 min	45 min	60 min	75 min	90 min	120 min
	GE-CT 18/28 Li TC		45 min	55 min	70 min	85 min	95 min	115 min	120 min
	GE-CT 18/28 Li		45 min	55 min	70 min	85 min	95 min	115 min	120 min
	GE-CT 18 Li		55 min	65 min	80 min	125 min	160 min	180 min	250 min
	GC-CT 18/24 Li		55 min	65 min	80 min	125 min	160 min	180 min	250 min
	GC-CT 18/24 Li P		55 min	65 min	80 min	125 min	160 min	180 min	250 min
Cordless Lawn Edge Trimmer	GE-LE 18/190 Li		25 min	33 min	45 min	55 min	65 min	75 min	110 min
Cordless Grout Cleaner	GC-CC 18 Li		45 min	50 min	60 min	90 min	120 min	135 min	180 min
Cordless Surface Brush	PICOBELLA		10-30 min	12-34 min	17-46 min	20-55 min	25-70 min	29-90 min	40-110 min
Cordless Hedge Trimmers	GE-CH 36/65 Li		75 min	93 min	120 min	150 min	180 min	225 min	300 min
	GE-CH 36/61 Li		72 min	80 min	105 min	144 min	168 min	210 min	288 min
	GE-CH 18/60 Li		45 min	53 min	70 min	90 min	110 min	135 min	180 min
	ARCURRA 18/55		45 min	53 min	70 min	90 min	110 min	135 min	180 min
	GC-CH 1855/1 Li		80 min	100 min	120 min	160 min	210 min	240 min	320 min
	GC-CH 1846 Li		80 min	100 min	120 min	160 min	210 min	240 min	320 min
	GC-CH 18/40 Li		53 min	67 min	80 min	106 min	139 min	160 min	212 min
Cordless Multifunctional Tools	GE-LM 36/4in1		34 min	41 min	54 min	68 min	86 min	108 min	136 min
			27 min	33 min	44 min	54 min	66 min	88 min	108 min
			28 min	33 min	40 min	56 min	66 min	80 min	112 min
			80 pcs	100 pcs	120 pcs	160 pcs	200 pcs	240 pcs	320 pcs
	GE-HC 18 Li T		40 pcs	48 pcs	60 pcs	75 pcs	100 pcs	120 pcs	150 pcs
Cordless Pole-Mounted Pruners	GE-LC 18 Li T		30 min	35 min	40 min	60 min	75 min	80 min	120 min
	GC-LC 18/20 Li T		50 pcs	65 pcs	75 pcs	100 pcs	130 pcs	135 pcs	200 pcs
Cordless Telescopic Hedge Trimmers	GE-HH 18/45 Li T		30 min	35 min	40 min	60 min	75 min	80 min	120 min
	GC-HH 18/45 Li T		28 min	33 min	40 min	56 min	66 min	80 min	112 min

THE BATTERY GUIDE – IT'S WHAT YOU NEED THAT MATTERS.

			18 V 2.0 Ah	18 V 2.5 Ah	18 V 3.0 Ah	18 V 4.0 Ah	18 V 5.2 Ah	18 V 6.0 Ah	18 V 8.0 Ah
Cordless Chainsaws	GP-LC 36/35 Li		160 pcs	200 pcs	240 pcs	320 pcs	420 pcs	480 pcs	640 pcs
	FORTEXXA 18/30	Eco High	78 pcs 70 pcs	98 pcs 88 pcs	117 pcs 105 pcs	156 pcs 140 pcs	203 pcs 182 pcs	234 pcs 210 pcs	280 pcs 312 pcs
	FORTEXXA 18/20 TH		80 pcs	100 pcs	120 pcs	160 pcs	208 pcs	240 pcs	320 pcs
	GE-LC 18/25 Li		70 pcs	85 pcs	100 pcs	130 pcs	180 pcs	200 pcs	260 pcs
Cordless Chain Sharpener	GE-CS 18 Li		240 min	300 min	390 min	480 min	660 min	780 min	960 min
Cordless Leaf Blowers	GP-LB 36/210 Li E		10-55 min	11-63 min	16-92 min	20-116 min	26-138 min	30-165 min	40-232 min
	GP-LB 18/200 Li GK		5-13 min	8-15 min	10-21 min	15-27 min	18-33 min	20-37 min	30-54 min
	GP-LB 18/200 Li E		5-13 min	8-15 min	10-21 min	15-27 min	18-33 min	20-37 min	30-54 min
	GC-CL 18 Li E		14-240 min	16-300 min	20-390 min	26-480 min	40-660 min	42-720 min	52-960 min
Cordless Universal Blowers	GE-UB 18/250 Li E		10-65 min	12-80 min	14-96 min	20-130 min	24-166 min	28-192 min	40-260 min
	GC-CL 18/1 Li E		14-240 min	16-300 min	20-390 min	26-480 min	40-660 min	42-720 min	52-960 min
Cordless Leaf Vacuums	VENTURRO 36/240	Suction Blowing	10-28 min 11-31 min	12-33 min 13-37 min	16-43 min 18-48 min	21-56 min 22-62 min	26-70 min 28-77 min	33-86 min 36-97 min	42-112 min 44-122 min
	VENTURRO 18/210	Suction Blowing	0-14 min 4-15 min	5-18 min 5-19 min	7-20 min 7-22 min	9-30 min 9-32 min	11-42 min 13-40 min	15-45 min 14-48 min	18-60 min 18-64 min
	GE-CL 36 Li E	Suction Blowing	10-30 min 13-35 min	13-35 min 16-40 min	17-45 min 21-60 min	22-65 min 27-75 min	27-90 min 32-105 min	30-100 min 39-120 min	44-130 min 54-150 min
	GE-CL 36/230 Li E	Suction Blowing	12-28 min 13-29 min	14-34 min 16-35 min	20-45 min 24-50 min	24-55 min 27-58 min	30-75 min 37-79 min	35-85 min 43-91 min	48-110 min 54-116 min
Cordless Grass and Shrub Shears	GE-CG 18/100 Li T		240 min	300 min	360 min	480 min	650 min	720 min	960 min
	GE-CG 18/100 Li		240 min	300 min	360 min	480 min	650 min	720 min	960 min
	GC-CG 18 Li		240 min	300 min	360 min	480 min	650 min	720 min	960 min
	GC-CG 18/1 Li		240 min	300 min	360 min	480 min	650 min	720 min	960 min
Cordless Pruning Saw	GE-GS 18 Li		90 pcs	115 pcs	140 pcs	180 pcs	240 pcs	280 pcs	360 pcs
Cordless Pruning Shears	GE-LS 18 Li		1426 pcs	1783 pcs	2139 pcs	2852 pcs	3708 pcs	4278 pcs	5704 pcs
Cordless Pressure Sprayers	GE-WS 18/150 Li		2.5 h	3.5 h	4 h	5 h	7 h	8.5 h	10 h
	GE-WS 18/75 Li		6 h	7.5 h	10 h	12 h	16 h	20 h	24 h
	GE-WS 18/35 Li		6 h	7.5 h	10 h	12 h	16 h	20 h	24 h
Cordless Hot Air Generator	GE-HG 18/370 Niro Li		140 min	160 min	180 min	280 min	330 min	380 min	560 min

			18 V 2,0 Ah	18 V 2,5 Ah	18 V 3,0 Ah	18 V 4,0 Ah	18 V 5,2 Ah	18 V 6,0 Ah	18 V 8,0 Ah
Cordless Garden Pump	AQUINNA 36/30	BOOST ECO	15 min 35 min	23 min 47 min	30 min 55 min	35 min 70 min	45 min 85 min	50 min 100 min	70 min 140 min
	GE-PP 18 RB Li		15 min	20 min	25 min	30 min	35 min	45 min	60 min
Cordless Clear Water Pumps	GE-SP 18 Li		30 min	35 min	40 min	60 min	70 min	80 min	120 min

70 pcs

BASIC PERFORMANCE – Upgrade recommended

Figures shown in lighter fields (for example see above) indicate that we recommend using a battery with greater power/capacity for full power and the appropriate operating time of the machine.

Key to Symbols:

- Max. number of starts per battery charge
- Max. workable area per battery charge
- Max. workable area per battery charge with 2 or 4 batteries (either 2 or 4 batteries can be inserted in the GE-CM 36/47!)
- Max. operating time per battery charge in idle mode
- Max. number of drill holes (depth 40 cm, mixed floor) per battery charge
- Max. operating time per battery charge in idle mode (with blade)
- Max. operating time per battery charge in idle mode (with line spool)
- Max. operating time per battery charge in idle mode (with hedge trimmer)
- Max. number of cuts through 70 x 70 mm square timber per battery charge
- Max. number of cuts per battery charge through roundwood ø 60 mm
- Max. number of cuts per battery charge through dry birch branches ø 15 mm
- Suction / blowing:
Operating time if the blowing or suction function is used
- BOOST / ECO: Operating time in Boost or Eco mode

All stated values are maximum values. They were determined under standardised test conditions and may differ from the values achievable in everyday operation.

CHARGING TIMES

Power X-Charger 3 A								
Power X-Twincharger 3 A (parallel charging of 2 batteries)	30 min	40 min	50 min	60 min	75 min	100 min	120 min	150 min
Power X-Car Charger 3 A								
Power X-Fastcharger 4 A								
2x2 Power X-Quattrocharger 4 A (parallel charging of 2 batteries)	24 min	30 min	37 min	45 min	60 min	80 min	90 min	120 min
Power X-Boostcharger 6 A	24 min	30 min	27 min	32 min	40 min	50 min	60 min	80 min

Shorter charging time

-25%

-50%

LAWN AND SOIL CARE





ROBOT LAWN MOWER

BRUSHLESS
ENERGY
Einhell



	GC-RM 500 CLASSIC
Battery voltage / capacity	28 V / 2.0 Ah
For lawn areas of up to approx.*	500 m ²
Cutting width	18 cm
Cutting height adjustment	infinitely / 20-60 mm / central
Suitable for slopes up to	35%
Impact, lift and tilt sensors	•
Brushless motor	•
Integrated carry handle	•
Number of batteries / number of charging units	1 / 1
Supplied with perimeter wire	130 m
Supplied with fastening hooks	190 pcs
Supplied with accessories	3 connecting clamps, 3 blades
Article number	34.139.30

* The stated area coverage is based on the assumption of ideal conditions



ROBOT LAWN MOWERS ACCESSORIES



	Robot Lawn Mower Garage
Items supplied	1 pc
Foldable	•
Length x width x height	77.0 x 59.0 x 39.5 cm
Suitable for	all Einhell robot lawn mowers
Article number	34.140.24



ROBOT LAWN MOWERS ACCESSORIES

		Article number	EAN	Items supplied	Suitable for
	Perimeter Wire	34.140.21	4 006825 648782	1 pc (50 m)	all Einhell robot lawn mowers
	Spare Blades	34.140.20	4 006825 648775	12 pcs	
	Fastening Hooks	34.140.23	4 006825 648805	100 pcs	
	Connection Clamps	34.140.22	4 006825 648799	4 pcs	
	Repair Kit	34.140.26	4 006825 657968	5 m perimeter wire, 15 fastening hooks, 8 connecting clamps	
	Cleaning Set	34.140.25	4 006825 657951	Gloves, brush, scouring pad, microfiber cloth, screwdriver, spatula	

ELECTRIC LAWN MOWERS



	GC-EM 1700/42 CLASSIC	GC-EM 1500/36 CLASSIC NEW	GC-EM 1000/30 CLASSIC
Mains connection / rated input	230 - 240 V ~ 50 Hz / 1700 W	220 - 240 V ~ 50 Hz / 1500 W	220 - 240 V ~ 50 Hz / 1000 W
Cutting width	42 cm	36 cm	30 cm
Cutting height adjustment	6 levels / 20 - 65 mm / central	5 levels / 25 - 65 mm / central	3 levels / 30 - 70 mm / axial
Grass box capacity	50 l	38 l	25 l
Wheel diameter front / rear	150 mm / 230 mm	140 mm / 200 mm	140 mm / 140 mm
Housing material	Plastic	Plastic	Plastic
For lawn areas of up to approx.	700 m ²	600 m ²	300 m ²
Product weight	11.8 kg	10.0 kg	11.2 kg
Mulching function	-	-	-
Highwheels	•	•	-
Integrated carry handle	•	•	•
Cable-relief clip	•	•	•
Height-adjustable handlebar	•	•	-
Folding handlebar	•	•	•
Quick clamping function	•	•	-
Grass box with level indicator	•	•	-
Wide wheels exert less stress on the lawn	•	•	•
Article number	34.001.60	34.001.56	34.001.22



ELECTRIC LAWN MOWERS



	GC-EM 1743 HW CLASSIC	GC-EM 1437 CLASSIC	GC-EM 1032 CLASSIC
Mains connection / rated input	230 V ~ 50 Hz / 1700 W	230 V ~ 50 Hz / 1400 W	230 V ~ 50 Hz / 1000 W
Cutting width	43 cm	37 cm	32 cm
Cutting height adjustment	6 levels / 20 - 70 mm / central	3 levels / 25 - 60 mm / axial	3 levels / 25 - 60 mm / single
Grass box capacity	52 l	36 l	30 l
Wheel diameter front / rear	170 mm / 235 mm	140 mm / 170 mm	140 mm / 140 mm
Housing material	Plastic	Plastic	Plastic
For lawn areas of up to approx.	700 m ²	500 m ²	300 m ²
Product weight	13.7 kg	9.3 kg	8.2 kg
Mulching function	-	-	-
Highwheels	•	-	-
Integrated carry handle	•	•	•
Cable-relief clip	•	•	•
Height-adjustable handlebar	•	•	•
Folding handlebar	•	•	•
Quick clamping function	-	-	-
Grass box with level indicator	•	-	•
Wide wheels exert less stress on the lawn	•	•	•
Article number	34.005.90	34.002.85	34.002.57



PETROL LAWN MOWERS



Petrol Lawn Mower
GC-PM 56/2 S HW

VORTEX DECK

Special flow-optimized deck with perfect mowing and catching characteristics

FILLING LEVEL INDICATOR

CENTRAL CUTTING HEIGHT ADJUSTMENT

For easy and individual selection of the cutting height

SIDE DISCHARGE

MULCHING FUNCTION

DEFLECTOR REAR DISCHARGE

Cuttings ejected to the rear without a catch basket for maximum grass heights

CLEANING POSITION

Adjustment option for comfortable cleaning

PETROL LAWN MOWERS

5-IN-1
 • MOWING
 • MULCHING
 • SIDE DISCHARGE
 • DEFLECTOR REAR DISCHARGE
 • CATCHING



	GC-PM 56/2 S HW CLASSIC	GC-PM 52/2 S HW CLASSIC
Engine / displacement	4-stroke engine / 173 cm ³	4-stroke engine / 173 cm ³
Power / working speed	2.8 kW / 2850 min ⁻¹	2.8 kW / 2850 min ⁻¹
Cutting width	56 cm	52 cm
Cutting height adjustment	6 levels / 25 - 70 mm / central	6 levels / 25 - 70 mm / central
Grass box capacity	80 l	80 l
Wheel diameter front / rear	200 mm / 280 mm	200 mm / 280 mm
Housing material	Powder-coated sheet steel	Powder-coated sheet steel
For lawn areas of up to approx.	2200 m ²	1800 m ²
Product weight	42.7 kg	41.7 kg
5-in-1 function	•	•
Highwheels	•	•
Self-propelling	•	•
Lawn comb and built-in lifting handle	•	•
Cleaning and storage position	•	•
Vortex Technology deck	•	•
Height-adjustable handlebar	•	•
Folding handlebar	•	•
Grass box with level indicator	•	•
Cleaning tool	•	•
Article number	34.048.60	34.048.50



4 006825 646450



4 006825 646443

PETROL LAWN MOWER (POWER X-CHANGE ELECTRIC START)



	GC-PM 46 SM HW-E Li CLASSIC NEW
Engine / displacement	4-stroke engine / 146 cm ³
Power / working speed	2.0 kW / 2900 min ⁻¹
PXC battery voltage / capacity	1x 18 V / 2.0 Ah
Charging time	2.5 h
Cutting width	46 cm
Cutting height adjustment	9 levels / 25 - 80 mm / central
Grass box capacity	65 l
Wheel diameter front / rear	204 mm / 280 mm
Housing material	Powder-coated sheet steel
For lawn areas of up to approx.	1400 m ²
Product weight	32.5 kg
Highwheels	•
Self-propelling	•
Electric start function with PXC battery (18 V)	•
Mulching function	•
Height-adjustable long handle with soft grip	•
Grass box with level indicator	•
Lawn comb	•
Number of batteries / number of chargers	1 / 1
Article number	34.075.60



EINHELL VORTEX TECHNOLOGY

The metal deck is specially designed for an optimum airflow. Thanks to the special shape, the rotating blade generates strong suction which straightens up the grass before it is cut. Only then it is cut and then shredded with great force in the optimized airflow and ejected afterwards.



LUSHER GREEN THANKS TO MULCHING

Many Einhell lawn mowers can be converted to a mulch mower by fitting a mulching adapter.

The grass is shredded several times and remains on the turf, where it quickly turns to compost. This fertilizes the lawn, reducing evaporation. That protects the lawn from drying out and provides ideal living conditions for microbes, which provide for melioration of the soil.

Care should be taken to cut the length of the stems by just a third at the most. The cuttings will be shredded more efficiently and drop right through to the ground as a result, so they are less of an intrusion when using the lawn. It also contributes to the formation of side shoots in the lawn. The lawn becomes thicker and more lushly green.



PETROL LAWN MOWERS



	GC-PM 51/3 S HW-E CLASSIC	GC-PM 46 S HW-E CLASSIC NEW
Engine / displacement	4-stroke engine / 170 cm ³	4-stroke engine / 146 cm ³
Power / working speed	2.7 kW / 2900 min ⁻¹	2.0 kW / 2900 min ⁻¹
Cutting width	51 cm	46 cm
Cutting height adjustment	6 levels / 30 - 80 mm / central	9 levels / 25 - 80 mm / central
Grass box capacity	70 l	65 l
Wheel diameter front / rear	204 mm / 280 mm	204 mm / 280 mm
Housing material	Powder-coated sheet steel	Powder-coated sheet steel
For lawn areas of up to approx.	1800 m ²	1400 m ²
Product weight	35.0 kg	33.5 kg
Side ejector	•	-
Mulching function	•	-
Highwheels	•	•
Self-propelling	•	•
Electric start function	•	•
Lawn comb	-	•
Height-adjustable handlebar	•	•
Folding handlebar	•	•
Grass box with level indicator	•	•
Article number	34.048.70	34.075.70



4 006825 655285



4 006825 663143

PETROL LAWN MOWERS



LAWN MOWERS ACCESSORIES



	GC-PM 51/3 S HW CLASSIC
Engine / displacement	4-stroke engine / 170 cm ³
Power / working speed	2.7 kW / 2900 min ⁻¹
Cutting width	51 cm
Cutting height adjustment	6 levels / 30 - 80 mm / central
Grass box capacity	70 l
Wheel diameter front / rear	204 mm / 280 mm
Housing material	Powder-coated sheet steel
For lawn areas of up to approx.	1800 m ²
Product weight	31.5 kg
Side ejector	•
Mulching function	•
Highwheels	•
Self-propelling	•
Electric start function	-
Height-adjustable handlebar	•
Folding handlebar	•
Grass box with level indicator	•
Article number	34.043.33

	Quick Start Spray ACCESSORY NEW
Suitable for	petrol lawn mowers
Article number	34.030.98



4 006825 662450



4 006825 655261

PETROL LAWN MOWERS



	GC-PM 46/5 S CLASSIC NEW	GC-PM 46/3 CLASSIC NEW
Engine / displacement	4-stroke engine / 132 cm ³	4-stroke engine / 132 cm ³
Power / working speed	2.0 kW / 2900 min ⁻¹	2.0 kW / 2900 min ⁻¹
Cutting width	46 cm	46 cm
Cutting height adjustment	9 levels / 25 - 80 mm / central	9 levels / 25 - 80 mm / central
Grass box capacity	65 l	65 l
Wheel diameter front / rear	178 mm / 204 mm	178 mm / 204 mm
Housing material	Powder-coated sheet steel	Powder-coated sheet steel
For lawn areas of up to approx.	1400 m ²	1200 m ²
Product weight	26.0 kg	23.5 kg
Mulching function	-	-
Self-propelling	•	-
Height-adjustable handlebar	•	•
Folding handlebar	•	•
Grass box with level indicator	•	•
Article number	34.075.50	34.075.40



PETROL LAWN MOWERS



	GC-PM 40/2 S CLASSIC NEW	GC-PM 40/2 CLASSIC NEW
Engine / displacement	4-stroke engine / 132 cm ³	4-stroke engine / 132 cm ³
Power / working speed	2.0 kW / 2900 min ⁻¹	2.0 kW / 2900 min ⁻¹
Cutting width	40 cm	40 cm
Cutting height adjustment	7 levels / 25 - 75 mm / central	3 levels / 25 - 60 mm / single
Grass box capacity	45 l	45 l
Wheel diameter front / rear	178 mm / 203 mm	152 mm / 152 mm
Housing material	Plastic	Plastic
For lawn areas of up to approx.	1000 m ²	800 m ²
Product weight	21.2 kg	18.3 kg
Mulching function	-	-
Self-propelling	•	-
Height-adjustable handlebar	-	-
Folding handlebar	•	•
Grass box with level indicator	•	•
Article number	34.048.23	34.048.33



MANUAL LAWN MOWERS

LONG HANDLE

Ergonomically shaped and equipped with a soft grip for perfect handling

HEIGHT ADJUSTABLE LONG HANDLE

The height-adjustable long handle can be adjusted to users of all sizes for ergonomic and user-friendly mowing

BALL BEARING MOWING SPINDLE

with 5 high-quality precision-ground cutting blades for a perfect cut

Manual Lawn Mower
GE-HM 38 S-F

QUIET & EFFORTLESS

Thanks to the contactless cutting technology there is reduced friction loss which allows for easier and quieter working

GRASS CATCH BOX

The removable grass catch box has a capacity of 26 l

CUTTING HEIGHT ADJUSTMENT

The 4-stage cutting height adjustment ensures a precise cutting result



MANUAL LAWN MOWERS



	GE-HM 38 S-F EXPERT
Cutting width	38 cm
Cutting height adjustment	4 levels / 13 - 38 mm
Grass box capacity	26 l
Number of mowing blades	5
Mowing spindle diameter	125 mm
Wheel diameter	220 mm
For lawn areas of up to approx.	250 m ²
Product weight	8.4 kg
Wide wheels exert less stress on the lawn	•
Parking position	•
Height-adjustable handlebar	•
Contactless	•
Catch bag	•
Article number	34.141.61



MANUAL LAWN MOWERS



	GE-HM 38 S EXPERT
Cutting width	38 cm
Cutting height adjustment	4 levels / 13 - 38 mm
Grass box capacity	-
Number of mowing blades	5
Mowing spindle diameter	125 mm
Wheel diameter	220 mm
For lawn areas of up to approx.	250 m ²
Product weight	7.8 kg
Wide wheels exert less stress on the lawn	•
Parking position	•
Height-adjustable handlebar	•
Contactless	•
Catch bag	-
Article number	34.141.65



MANUAL LAWN MOWERS



	GC-HM 400 CLASSIC
Cutting width	40 cm
Cutting height adjustment	4 levels / 13 - 37 mm
Grass box capacity	27 l
Number of mowing blades	5
Mowing spindle diameter	125 mm
Wheel diameter	218 mm
For lawn areas of up to approx.	250 m ²
Product weight	7.2 kg
Wide wheels exert less stress on the lawn	•
Parking position	•
Height-adjustable handlebar	-
Contactless	-
Article number	34.141.29



	GC-HM 300 CLASSIC
Cutting width	30 cm
Cutting height adjustment	4 levels / 13 - 37 mm
Grass box capacity	16 l
Number of mowing blades	5
Mowing spindle diameter	125 mm
Wheel diameter	218 mm
For lawn areas of up to approx.	150 m ²
Product weight	6.5 kg
Wide wheels exert less stress on the lawn	•
Parking position	•
Height-adjustable handlebar	-
Contactless	-
Article number	34.141.14



SCARIFIERS / AERATORS

LONG HANDLE

The folding long handle with quick clamping function enables easy and compact storage

CARRY HANDLE

Comfortable transport thanks to the ergonomic carry handle

CENTRAL HEIGHT ADJUSTMENT

Easy and user-friendly adjustment to the desired working depth

QUICK TOOL CHANGE

The scarifier and aerator rollers can be changed quickly using the supplied tools

CATCH BAG

The large catch bag means long work sessions are no problem



Electric Scarifier/Aerator
GE-SA 1640

ELECTRIC SCARIFIERS/AERATORS

3-IN-1

- SCARIFYING
- AERATING
- CATCHING



	GE-SA 1640 EXPERT	GE-SA 1435 EXPERT	GE-SA 1433 EXPERT
Mains connection / rated input	230 V ~ 50 Hz / 1600 W	230 V ~ 50 Hz / 1400 W	230 V ~ 50 Hz / 1400 W
Working width	400 mm	350 mm	330 mm
Working depth adjustment	4 levels (central) + transport position	3 levels (central) + transport position	3 levels (central) + parking position
Number of blades (ball bearing)	20 pcs	20 pcs	20 pcs
Number of aerating claws (ball bearing)	30 pcs	26 pcs	48 pcs
Wheel diameter front / rear	220 mm / 175 mm	175 mm / 152 mm	175 mm / 152 mm
Housing material	Plastic	Plastic	Plastic
For lawn areas of up to approx.	800 m ²	500 m ²	400 m ²
Product weight	12.5 kg	11.5 kg	12.5 kg
Integrated carry handle	•	•	•
Height-adjustable handlebar + parking position	•	•	•
Folding handlebar	•	•	•
Quick fasteners	•	•	•
Wide wheels exert less stress on the lawn	•	•	•
Catch bag	•	•	•
Wall bracket	-	-	•
Aerator roller and scarifier roller	•	•	•
Article number	34.205.90	34.205.61	34.205.20



ELECTRIC SCARIFIERS/AERATORS



	GC-SA 1231/1 CLASSIC	GC-ES 1231/1 CLASSIC
Mains connection / rated input	230 V ~ 50 Hz / 1200 W	230 V ~ 50 Hz / 1200 W
Working width	310 mm	310 mm
Working depth adjustment	3 levels (central) + parking position	3 levels (central) + parking position
Number of blades (ball bearing)	8 double-knives	8 double-knives
Number of aerating claws (ball bearing)	45 pcs	-
Wheel diameter front / rear	180 mm / 100 mm	180 mm / 100 mm
Housing material	Plastic	Plastic
For lawn areas of up to approx.	300 m ²	300 m ²
Product weight	8.5 kg	8.0 kg
Integrated carry handle	•	•
Height-adjustable handlebar	•	•
Folding handlebar	•	•
Quick fasteners	-	-
Wide wheels exert less stress on the lawn	•	•
Catch bag	•	-
Scarifier roller	•	•
Aerator roller	•	-
Article number	34.206.40	34.206.30



4 006825 628272



4 006825 628289

PETROL SCARIFIER



	GC-SC 4240 P CLASSIC
Engine / displacement	4-stroke engine / 212 cm ³
Power rating	4.2 kW
Working width	400 mm
Working depth adjustment	8 levels (central) + transport position
Number of blades (ball bearing)	18 pcs
Wheel diameter front / rear	180 mm / 180 mm
Housing material	Metal
For lawn areas of up to approx.	1200 m ²
Product weight	30.7 kg
Folding handlebar	•
Wide wheels exert less stress on the lawn	•
Catch bag	•
Scarifier roller	•
Article number	34.200.19



4 006825 638073

GARDEN ROLLER



	GC-GR 57 CLASSIC
Working width	57 cm
Roller diameter	32 cm
Filling quantity	46 l
Housing material	Coated metal
Product weight	10.5 kg
Filling with sand	•
Filling with water	•
Article number	34.153.02



ELECTRIC GROUT CLEANER



	GC-EG 1410 CLASSIC
Mains connection / rated input	230 - 240 V ~ 50 Hz / 140 W
Diameter of brush	100 mm
Housing material	Plastic
Product weight	1.5 kg
Guide wheel	•
Cable-relief clip	•
Steel brush (15 mm wide)	•
Nylon brush (10 mm wide)	•
Article number	34.240.02



MULTI-PURPOSE SPREADER



	GC-SR 12 CLASSIC
Spread width	45 cm
Capacity of grit box	12 l
Wheel diameter	200 mm
Product weight	2.5 kg
Double push-bar	•
Spreading volume adjuster	•
Corrosion-resistant roller	•
Spring lock - device dismountable without tools	•
Article number	34.152.38



ELECTRIC LAWN TRIMMERS



	GC-ET 4530 Set CLASSIC
Mains connection / rated input	230 V ~ 50 Hz / 450 W
Cutting width (thread)	300 mm
Thread diameter / length	1.4 mm / 1000 cm
Single / twin line cutting	Twin line cutting
Housing material	Plastic
Product weight	2.6 kg
Additional handle	•
Telescopic long handle	•
Cable-relief clip	•
Motor head rotateable	180°
Motor head can be tilted	4 settings
Flower guard	•
Automatic jog line feed	-
Fully automatic line feed	•
Edge roller	-
Thread spool	• (3 pcs)
Article number	34.020.22



ELECTRIC LAWN TRIMMERS



	GC-ET 3023 CLASSIC
Mains connection / rated input	230 V ~ 50 Hz / 300 W
Cutting width (thread)	230 mm
Thread diameter / length	1.5 mm / 600 cm
Single / twin line cutting	Single line cutting
Housing material	Plastic
Product weight	1.5 kg
Additional handle	•
Telescopic long handle	-
Cable-relief clip	•
Motor head rotateable	-
Motor head can be tilted	-
Flower guard	-
Automatic jog line feed	•
Fully automatic line feed	-
Edge roller	-
Thread spool	•
Article number	34.020.50



	GC-ET 2522 CLASSIC
Mains connection / rated input	230 - 240 V ~ 50 Hz / 250 W
Cutting width (thread)	220 mm
Thread diameter / length	1.2 mm / 600 cm
Single / twin line cutting	Twin line cutting
Housing material	Plastic
Product weight	1.1 kg
Additional handle	•
Telescopic long handle	-
Cable-relief clip	•
Motor head rotateable	-
Motor head can be tilted	-
Flower guard	-
Automatic jog line feed	•
Fully automatic line feed	-
Edge roller	-
Thread spool	•
Article number	34.020.40



PETROL LAWN TRIMMER



	GC-PT 2538/1 I AS CLASSIC
Engine / displacement	2-stroke engine / 25.4 cm ³
Power rating	0.6 kW
Cutting width (thread)	380 mm
Thread diameter / length	2 mm / 400 cm
Single / twin line cutting	Twin line cutting
Housing material	Plastic
Product weight	5.6 kg
Shaped long handle made of aluminium	•
Split shaft	•
Quick Start	•
Autochoke	•
Centrifugal clutch for cutting tool	•
Automatic jog line feed	•
Article number	34.019.38



4 006825 643800

PETROL MULTI-FUNCTIONAL TOOL



	GC-MM 52 I AS CLASSIC
Engine / displacement	2-stroke engine / 51.7 cm ³
Power rating	1.5 kW
Cutting width (double thread)	420 mm
Thread diameter / length	2.4 mm / 400 cm
Cutting width (blade)	255 mm
Cutting length chainsaw	255 mm
Chain cutting speed	21.3 m/s
Blade length of hedge trimmer	395 mm
Spacing between teeth (hedge trimmer)	31 mm
Max. working height of elevated tools	3.5 m (pole-mounted pruner) / 3.5 m (hedge trimmer)
Extendable handle	•
Long handle made of aluminium tube	•
Split shaft	•
Autochoke	•
Digital ignition – stable engine run	•
Automatic jog line feed	•
Cutting unit (hedge trimmer) tiltable	•
Laser-cut and diamond-ground blades	•
OREGON quality bar and chain	•
Automatic chain lubrication	•
Adjustable handle	•
Protective cover	•
Carrying belt with quick release	•
Article number	34.365.55



4 006825 641684

POWER TOOLS ACCESSORIES



	Petrol and Oil Suction Pump
Suction hose length	1.3 m
Collecting container	1.6 l
Article number	34.070.00



4 006825 547276

PETROL SCYTHES

BIKE HANDLE

The universally adjustable aluminium handle in bike handle design with integral controls enables ergonomic operation with the maximum possible control

SPLIT SHAFT

User-friendly plug-together system for stowing away quickly and compactly

ALUMINIUM SHAFT

Low weight – easy to work with

SPINDLE LOCK SYSTEM

Blade and line spool are easily replaced with just a push of the button

Petrol Scythe
GE-BC 43 AS

EASY START

For easy starting the power scythe has an auto choke and decompression valve

ANTI-VIBRATION SYSTEM

3-way rubber shock absorber on handle keeps tiredness at bay

PROFESSIONAL HIGH COMFORT HARNESS

Complete with harness for comfortable and high power work

PETROL SCYTHES



	GE-BC 43 AS EXPERT
Engine / displacement	2-stroke engine / 42.7 cm ³
Power rating	1.25 kW
Cutting width (double thread)	460 mm
Thread diameter / length	2.4 mm / 600 cm
Cutting width (blade)	255 mm
Housing material	Aluminium/plastics
Product weight	10.0 kg
Handle with all control elements	•
Long handle made of aluminium tube	•
Split shaft	•
Quick Start System + Autochoke	•
Spindle Lock System	•
Anti-vibration system	•
Automatic jog line feed	•
Professional high comfort harness	•
Wall bracket	•
Blade + thread spool	•
Article number	34.046.10



4 006825 594751

PETROL SCYTHES



	GC-BC 36-4 S CLASSIC	GC-BC 52 I AS CLASSIC
Engine / displacement	4-stroke engine / 37.7 cm ³	2-stroke engine / 51.7 cm ³
Power rating	1.0 kW	1.5 kW
Cutting width (double thread)	420 mm	420 mm
Thread diameter / length	2.4 mm / 400 cm	2.4 mm / 400 cm
Cutting width (blade)	255 mm	255 mm
Housing material	Aluminium/plastics	Aluminium/plastics
Product weight	8.7 kg	8.5 kg
Handle with all control elements	•	•
Long handle made of aluminium tube	•	•
Split shaft	•	•
Quick Start System	•	•
Autochoke	-	•
Digital ignition – stable engine run	•	•
Automatic jog line feed	•	•
Comfort harness	•	•
Blade + thread spool	•	•
Article number	34.365.60	34.365.40



PETROL SCYTHES



	GH-BC 43 AS CLASSIC	GC-BC 30/1 I AS CLASSIC	GC-BC 25/1 I AS CLASSIC
Engine / displacement	2-stroke engine / 42.7 cm ³	2-stroke engine / 29.7 cm ³	2-stroke engine / 25.4 cm ³
Power rating	1.25 kW	1.0 kW	0.6 kW
Cutting width (double thread)	420 mm	420 mm	420 mm
Thread diameter / length	2.4 mm / 400 cm	2.0 mm / 400 cm	2.0 mm / 400 cm
Cutting width (blade)	255 mm	230 mm	230 mm
Housing material	Aluminium/plastics	Aluminium/plastics	Aluminium/plastics
Product weight	8.8 kg	6.7 kg	7.3 kg
Handle with all control elements	•	•	•
Long handle made of aluminium tube	•	•	•
Split shaft	•	•	•
Quick Start System + Autochoke	•	•	•
Digital ignition – stable engine run	•	•	•
Automatic jog line feed	•	•	•
Comfort harness	•	•	•
Blade + thread spool	•	•	•
Article number	34.019.73	34.365.25	34.019.57



PETROL TILLERS



	GC-MT 4280 CLASSIC	NEW	GC-MT 2560 LD CLASSIC
Engine / displacement	4-stroke engine / 212 cm		4-stroke engine / 150 cm ³
Power / working speed	4.2 kW / 3600 min ⁻¹		2.5 kW / 3400 min ⁻¹
Working width	890 mm		600 mm
Working depth	320 mm		230 mm
Number of blades	6		6
Cultivator blade diameter	360 mm		260 mm
Fuel tank capacity	3.6 l		1.2 l
Product weight	75.0 kg		41.3 kg
Side limiting discs	•		•
Swivelling guide wheel	•		•
Quick Start	•		•
Cultivator blade stopped by dead man's circuit	•		•
Ergonomic handlebar	•		•
Height adjustable steady grips	•		•
Height adjustable brake shoe	•		•
Reverse gear	•		-
Wheels (for the use of accessories)	•		-
Article number	34.315.10		34.302.81



PETROL TILLERS



	GC-MT 2236 CLASSIC
Engine / displacement	4-stroke engine / 140 cm ³
Power / working speed	2.2 kW / 3200 min ⁻¹
Working width	360 mm
Working depth	220 mm
Number of blades	4
Cultivator blade diameter	260 mm
Fuel tank capacity	2.0 l
Product weight	32.5 kg
Side limiting discs	-
Swivelling guide wheel	•
Quick Start	•
Cultivator blade stopped by dead man's circuit	•
Ergonomic handlebar	•
Height adjustable steady grips	•
Height adjustable brake shoe	•
Reverse gear	-
Wheels (for the use of accessories)	-
Article number	34.315.01



PETROL TILLERS ACCESSORIES



	Plow NEW	Potato Plow NEW
Suitable for	GC-MT 4280 (34.315.10)	GC-MT 4280 (34.315.10)
Article number	34.315.20	34.315.30



4 006825 663419



4 006825 663426

ELECTRIC TILLERS



	GC-RT 1545 M CLASSIC	GC-RT 7530 CLASSIC
Mains connection / rated input	230 - 240 V ~ 50 Hz / 1500 W	230 V ~ 50 Hz / 750 W
Working width	450 mm	300 mm
Working depth	220 mm	200 mm
Number of blades	6	4
Cultivator blade diameter	200 mm	220 mm
Product weight	11.6 kg	7.4 kg
Cable-relief clip	•	•
Overload protection	•	-
Height-adjustable wheels for easy transportation	•	-
Ergonomic handlebar	•	•
Folding handlebar	•	•
Article number	34.310.60	34.310.50



4 006825 652598



4 006825 602005

TREE AND SHRUB CARE



HEDGE TRIMMERS



Electric Hedge Trimmer
GE-EH 7067

■ **SWIVEL HANDLE**

Rear handle can be swiveled: optimum handling – for vertical and horizontal cuts without fatigue

■ **METAL GEARING**

Rugged metal gearing for efficient power transmission and long product life

■ **HAND GUARD**

For your safety, all hedge trimmers are equipped with a large hand guard

■ **CUTTING COLLECTOR**

Perfect removal of the cuttings from the top of the hedge when trimming hedges is ensured by the practical cuttings collector

■ **HIGH QUALITY BLADES**

The blades made of laser-cut and diamond ground steel are designed for maximum precision and durability



■ **ALUMINIUM COVER**

The product comes complete with a sturdy aluminium cover for protecting the blades

■ **IMPACT GUARD**

The impact guard protects the blades and the work area against damage



ELECTRIC HEDGE TRIMMERS

LONG LASTING SHARPNESS



TURNABLE HANDLE

LASERCUT & DIAMOND GROUND



GE-EH 7067

EXPERT

220 - 240 V ~ 50 Hz / 700 W

710 mm

670 mm

30 mm

3000 min⁻¹

3.5 kg

•

•

•

•

•

•

•

•

•

•

34.033.40



4 006825 616170



GE-EH 6560

EXPERT

220 - 240 V ~ 50 Hz / 650 W

660 mm

600 mm

30 mm

3000 min⁻¹

3.5 kg

•

•

•

•

•

•

•

•

•

•

34.033.30



4 006825 616163

ELECTRIC HEDGE TRIMMERS

LONG LASTING SHARPNESS



LONG LIFE METAL GEAR

LASERCUT & DIAMOND GROUND



GC-EH 6055/1

CLASSIC

220 - 240 V ~ 50 Hz / 600 W

610 mm

550 mm

26 mm

2800 min⁻¹

3.4 kg

-

•

•

•

•

•

•

•

•

•

34.033.20



4 006825 622157

ELECTRIC HEDGE TRIMMERS



	GC-EH 5747 CLASSIC	GC-EH 4550 CLASSIC	GH-EH 4245 CLASSIC
Mains connection / rated input	230 V ~ 50 Hz / 570 W	230 V ~ 50 Hz / 450 W	230 V ~ 50 Hz / 420 W
Bar length	530 mm	560 mm	510 mm
Cutting length	465 mm	500 mm	450 mm
Spacing between teeth	18 mm	16 mm	16 mm
Cuts per minute	3200 min ⁻¹	3200 min ⁻¹	3200 min ⁻¹
Product weight	2.8 kg	2.5 kg	2.5 kg
Turnable rear handle	-	-	-
Cutting collector	-	-	-
Laser-cut and diamond-ground blades	-	•	•
Metal gear box	•	•	•
Soft grip	•	•	•
Aluminium cover over cutters	-	•	•
Protection shield	•	•	•
Cable-relief clip	•	•	•
Protective cover with wall mount	•	•	•
Article number	34.037.42	34.033.70	34.034.60



PETROL HEDGE TRIMMER



	GE-PH 2555 A EXPERT
Power rating	0.85 kW
Engine displacement	24.5 cm ³
Bar length	610 mm
Cutting length	550 mm
Spacing between teeth	28 mm
Cuts per minute	2050 min ⁻¹
Product weight	5.5 kg
Swivel handle	•
Ergonomic handle	•
Anti-vibration system	•
Autochoke – Quick Start System	•
Laser-cut blades	•
Protection shield	•
Safety switch	•
Protective cover	•
Article number	34.038.35



HEDGE TRIMMERS ACCESSORY



	Maintenance Spray ACCESSORY
Suitable for	hedge trimmers, grass and shrub shears
Article number	34.030.99



CORDLESS GRASS AND SHRUB SHEARS



	GE-CG 12 Li EXPERT	GE-CG 12 Li WT EXPERT
Li-Ion Battery Pack	12 V / 1.5 Ah	12 V / 1.5 Ah
Charging time	2 h	2 h
Operating time per battery charge	100 min	100 min
Cutting width with grass shear blade	100 mm	100 mm
Cutting length with shrub cutting blade	190 mm	190 mm
Spacing between teeth of shrub cutting blade	8 mm	8 mm
Product weight	1.6 kg	0.8 kg
Blade change without tools	•	•
Telescopic handle	•	-
Large wheels	•	-
Laser-cut blades	•	•
Metal gear box	•	•
Soft grip	•	•
Battery charger	•	•
Article number	34.104.01	34.104.11



CORDLESS GRASS AND SHRUB SHEARS



	GC-CG 3.6/70 Li CLASSIC NEW	GC-CG 3.6/70 Li WT CLASSIC NEW
Li-Ion Battery Pack	3.6 V / 2.0 Ah	3.6 V / 2.0 Ah
Charging time	3-5 h	3-5 h
Operating time per battery charge	60 min	60 min
Cutting width with grass shear blade	70 mm	70 mm
Cutting length with shrub cutting blade	110 mm	110 mm
Spacing between teeth of shrub cutting blade	8 mm	8 mm
Product weight	1.0 kg	0.6 kg
Blade change without tools	•	•
Telescopic handle	•	-
Large wheels	•	-
Laser-cut blades	-	-
Metal gear box	-	-
Soft grip	•	•
Article number	34.103.60	34.103.65



ELECTRIC POLE-MOUNTED PRUNER



	GC-EC 7520 T CLASSIC NEW
Mains connection	220 - 240 V ~ 50 Hz
Rated input	750 W
Bar length	200 mm
Cutting length	180 mm
Cutting speed	11 m/s
Max. working height	3.0 m
Product weight	3.3 kg
Extendable handle	•
Toolless chain tensioning	•
Automatic chain lubrication	•
Large oil filler opening	•
Adjustable second handle	•
Protective cover	•
Carrying belt with quick release	•
Article number	45.012.40



ELECTRIC TELESCOPIC HEDGE TRIMMERS



	GC-HH 9048 CLASSIC	GC-HH 5047 CLASSIC
Mains connection	230 - 240 V ~ 50 Hz	230 V ~ 50 Hz
Rated input	900 W	500 W
Bar length	480 mm	585 mm
Cutting length	410 mm	470 mm
Spacing between teeth	20 mm	20 mm
Max. working height	3.0 m	3.0 m
Product weight	5.1 kg	4.0 kg
Extendable handle	•	•
Cutting head tiltable	•	•
Turnable rear handle	•	-
Laser-cut and diamond-ground blades	•	•
Metal gear box	•	-
Adjustable second handle	•	•
Protective cover	•	•
Carrying belt with quick release	•	•
Article number	34.034.92	34.032.00



ELECTRIC MULTI-FUNCTIONAL TOOL

FITTED WITH

 CHAIN AND BAR

LONG LASTING
 SHARPNESS

LASERCUT &
 DIAMOND GROUND



	GC-HC 9024 T CLASSIC
Mains connection	230 - 240 V ~ 50 Hz
Rated input	900 W
Bar length (chainsaw)	200 mm
Chain cutting speed	6.3 m/s
Blade length of hedge trimmer	410 mm
Spacing between teeth (hedge trimmer)	20 mm
Max. working height	3.0 m (pole-mounted pruner) / 3.0 m (hedge trimmer)
Product weight	4.2 kg (incl. all attachments)
Extendable handle	•
Cutting head tiltable	•
Turnable rear handle	•
OREGON quality bar and chain	•
Automatic chain lubrication	•
Laser-cut and diamond-ground blades	•
Adjustable second handle	•
Protective cover	•
Carrying belt with quick release	•
Article number	45.012.80



4 006825 615333

CHAINSAWS

HAND GUARD AND CHAIN BRAKE

Kickback protection with instant reaction mechanical chain brake and large hand guard for safe operation

ERGONOMIC HANDLE POSITIONS

For good and safe handling in all work situations – when cutting either vertically or horizontally – the handles are ergonomically positioned

Electric Chainsaw
GC-EC 2040

SOFT GRIP

Better grip, safe handling and ergonomic operation

OIL FILLING OPENING

The large opening in the oil reservoir allows the chain oil to be topped up easily

METAL STOP CLAW

The rugged metal stop claw keeps the saw stable for added safety and working comfort

HIGH-QUALITY CHAIN AND BAR FROM OREGON

FITTED WITH
OREGON
CHAIN AND BAR

CHAIN TENSIONING AND CHANGING WITHOUT TOOLS

User-friendly: Chain tensioning / changing and chainsaw adjustment without the need for additional tools

METAL GEARING

Rugged metal gearing for efficient power transmission and long product life

SOFT START

The soft start protects the equipment from overloading and provides enhanced user safety



ELECTRIC CHAINSAWS



FITTED WITH
OREGON
CHAIN AND BAR



	GE-EC 2240 EXPERT
Mains connection	220 - 240 V ~ 50/60 Hz
Rated input	2200 W
Bar length	406 mm
Cutting length	375 mm
Cutting speed	15 m/s
Oil tank capacity	150 ml
Product weight	5.6 kg
Metal gearing	•
OREGON quality bar and chain	•
Toolless chain tensioning and changing	•
Automatic chain lubrication	•
Sturdy stop claws made of metal	•
Kickback protection with mechanical instant chain brake	•
Chain catch bolt	•
Soft grip	•
Soft start	•
Protective cover	•
Article number	45.017.40



ELECTRIC CHAINSAWS



FITTED WITH
OREGON
CHAIN AND BAR

FITTED WITH
OREGON
CHAIN AND BAR



	GC-EC 2040 CLASSIC NEW	GC-EC 1935 CLASSIC NEW	GH-EC 1835 CLASSIC
Mains connection	230 - 240 V ~ 50 Hz	230 - 240 V ~ 50 Hz	230 - 240 V ~ 50 Hz
Rated input	2000 W	1900 W	1800 W
Bar length	400 mm	350 mm	350 mm
Cutting length	375 mm	325 mm	325 mm
Cutting speed	15.5 m/s	15.5 m/s	13.5 m/s
Oil tank capacity	160 ml	160 ml	160 ml
Product weight	4.9 kg	4.7 kg	5.4 kg
Metal gearing	•	•	•
OREGON quality bar and chain	•	•	-
Toolless chain tensioning and changing	•	•	•
Automatic chain lubrication	•	•	•
Sturdy stop claws made of metal	•	•	•
Kickback protection with mechanical instant chain brake	•	•	•
Chain catch bolt	•	•	•
Soft grip	•	•	•
Soft start	-	-	-
Protective cover	•	•	•
Article number	45.012.30	45.012.20	45.017.10



PETROL CHAINSAWS



	GC-PC 2040 I CLASSIC	GC-PC 1435 I TC CLASSIC
Power rating	2.0 kW / 2.7 PS	1.4 kW / 1.9 PS
Engine displacement	50.4 cm ³	41 cm ³
Bar length	400 mm	350 mm
Cutting length	390 mm	335 mm
Cutting speed	21 m/s	21 m/s
Fuel tank capacity	540 ml	260 ml
Oil tank capacity	240 ml	210 ml
Product weight	6.5 kg	5.5 kg
OREGON quality bar and chain	•	•
Digital ignition – stable engine run	•	•
Autochoke – Quick Start System + Primer	•	•
Toolless chain tensioning and changing	–	•
Automatic chain lubrication	•	•
Sturdy stop claws made of metal	•	•
Kickback protection with instant chain brake	•	•
Protective cover	•	•
Petrol/oil mixing bottle	•	•
Article number	45.018.51	45.018.29



PETROL CHAINSAWS



	GC-PC 1335/1 I CLASSIC	GC-PC 730 I CLASSIC
Power rating	1.3 kW / 1.7 PS	0.7 kW / 1.0 PS
Engine displacement	37.2 cm ³	25.4 cm ³
Bar length	350 mm	305 mm
Cutting length	345 mm	240 mm
Cutting speed	21.9 m/s	21 m/s
Fuel tank capacity	300 ml	230 ml
Oil tank capacity	170 ml	160 ml
Product weight	5.3 kg	3.8 kg
OREGON quality bar and chain	•	–
Digital ignition – stable engine run	•	•
Autochoke – Quick Start System + Primer	•	•
Toolless chain tensioning and changing	–	–
Automatic chain lubrication	•	•
Sturdy stop claws made of metal	•	•
Kickback protection with instant chain brake	•	•
Protective cover	•	•
Petrol/oil mixing bottle	•	•
Article number	45.018.70	45.018.42



ELECTRIC CHAIN SHARPENERS



	GC-CS 235 E CLASSIC	GC-CS 85 E CLASSIC
Mains connection	230 V - 50 Hz	220 - 240 V ~ 50 Hz
Rated input	235 W	85 W
Grinding wheel diameter (inside)	22 mm	23 mm
Grinding wheel diameter (outside)	145 mm	108 mm
Grinding wheel thickness	3.2 mm	3.2 mm
Product weight	5.8 kg	1.9 kg
Depth stop	•	•
Scale for precise setting of the grinding angle	•	•
Clamping device	•	•
Pivoting grinding head for setting the roof angle	•	-
Light	•	-
Transparent window	•	-
Article number	44.999.10	44.999.20



4 006825 613148



4 006825 613834

WOODWORKING ACCESSORIES



	Forest Safety Helmet	Combination Canister
Product weight	0.8 kg	0.8 kg
Article number	45.004.80	45.013.25



4 006825 544565



4 006825 542851



	Chainsaw Trestle	Moisture Meter
Product weight	7.1 kg	0.1 kg
Article number	45.000.67	45.016.22



4 006825 548693



4 006825 653984

ELECTRIC LEAF VACUUMS

2-IN-1

VACUUMING
BLOWING



AIR SPEED
MIN - MAX



	GC-EL 3000 E CLASSIC	GC-EL 3024 E CLASSIC
Mains connection	220 - 240 V ~ 50 Hz	230 - 240 V ~ 50 Hz
Rated input	3000 W	3000 W
Max. blow velocity	300 km/h	240 km/h
Max. suction power	840 m ³ /h	650 m ³ /h
Idle speed	8000 - 15000 min ⁻¹	7000 - 13500 min ⁻¹
Shredding function	15:1	10:1
Debris bag volume	45 l	40 l
Product weight	3.0 kg (blow) / 4.2 kg (vacuum)	3.1 kg
Toolless change-over between suction and blasting function	•	•
Electronic speed control	•	•
Additional handle	• (adjustable)	•
Cleaning flap with safety switch	•	-
Aluminum blower impeller	•	-
Guiding wheels	• (height adjustable)	•
Debris bag with window	•	•
Carrying strap	•	•
Soft grip	•	-
Article number	34.333.20	34.333.70



4 006825 629651



4 006825 658606



2-in-1

VACUUMING | BLOWING

* The GC-EL 3000 E is supplied complete with a large, wide suction tube and a light, narrow blower tube as well. This makes it easy to handle the equipment, and that goes for both the vacuum and the blowing function. Both functions are made available easily by converting from one to the other without the need for any tools.

GARDEN SHREDDERS



	GC-KS 2540 CB CLASSIC	GC-KS 2540 CLASSIC
Mains connection	220 - 240 V ~ 50 Hz	220 - 240 V ~ 50 Hz
Rated input	2500 W (P40) / 2000 W	2500 W (P40) / 2000 W
Idle speed	3800 min ⁻¹	3800 min ⁻¹
Max. branch diameter	40 mm	40 mm
Capacity of catch box	55 l	-
Product weight	13.0 kg	10.0 kg
Transport wheels	•	•
Transport handle	•	•
Generous funnel opening	•	•
Prodler incl.	•	•
Debris box	•	-
Garden rubbish bag	-	•
Article number	34.304.00	34.303.30



4 006825 652765



4 006825 638233

ELECTRIC ROLLER SHREDDERS



	GC-RS 60 CB CLASSIC	GC-RS 2540 CLASSIC
Mains connection	230 - 240 V ~ 50 Hz	230 V ~ 50 Hz
Rated input	2800 W (P40) / 2300 W	2500 W (P40) / 2000 W
Idle speed	40 min ⁻¹	40 min ⁻¹
Max. branch diameter	45 mm	40 mm
Capacity of catch box	60 l	-
Product weight	29.5 kg	24.9 kg
Transport wheels	•	•
Transport handle	•	•
Reverse running switch	•	•
Generous funnel opening	•	•
Prodler incl.	-	-
Debris box	•	-
Garden rubbish bag	-	•
Article number	34.306.35	34.306.20



4 006825 645880



4 006825 608403

WATERING AND DRAINAGE





WATERING + DRAINAGE

PROS AT A GLANCE



DRAINAGE

- Delivery of large quantities of water quickly
- Prevention of the worst water damage as far as possible by pumping out quickly
- High level of operational safety and reliability

WATERING

- Uniform garden watering
- User-friendly and safe handling
- Conserves resources and saves drinking water

DOMESTIC WATER SUPPLY

- Water supply for the home and garden from alternative water reservoirs (cisterns, wells)
- User-friendly and safe handling
- Conserves resources and saves drinking water

■ DRAINAGE

Repumping/pumping out water – quicker and easier than ever. Pumping both clear water and dirty water with a high delivery rate is no problem with Einhell drainage pumps.

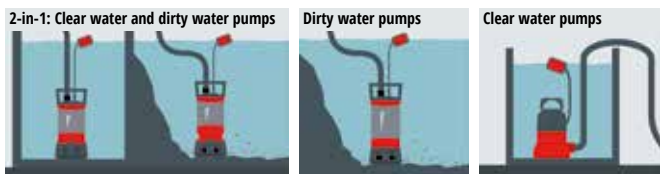

PRODUCTS

- 2-in-1 Multipurpose Pumps
- Dirty Water Pumps
- Clear Water Pumps
- Aqua Sensor Pumps

AREAS OF APPLICATION

- Pumping out flooded basements, garages or washing rooms
- Pumping out and repumping from pools, garden ponds, building pits and drainage channels



■ WATERING

To avoid wasting precious drinking water on watering the garden, alternative sources of water such as rainwater or water from cisterns can be used instead.

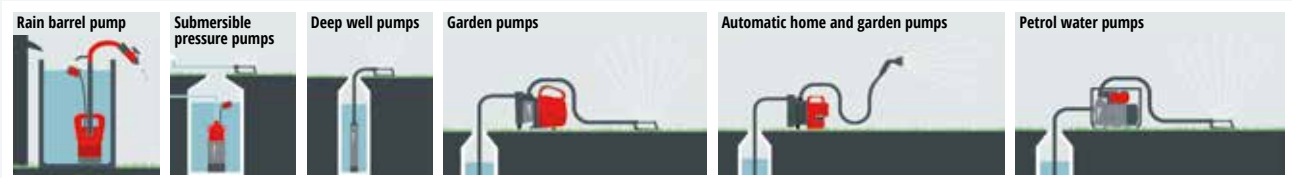

PRODUCTS

- Rain Barrel Pump
- Submersible Pressure Pumps
- Deep Well Pumps
- Garden Pumps
- Automatic Home and Garden Pumps
- Petrol Water Pumps

AREAS OF APPLICATION

- Operating lawn sprinklers and garden showers
- Pumping water from wells or cisterns
- Using rainwater from storage areas for watering



■ DOMESTIC WATER SUPPLY

Thanks to a wide range of uses, the home and garden can be supplied with service water automatically.

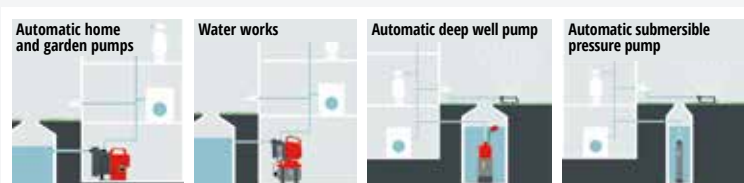

PRODUCTS

- Automatic Home and Garden Pumps
- Water Works
- Automatic Submersible Pressure Pumps
- Automatic Deep Well Pump

AREAS OF APPLICATION

- Water from alternative sources for supplying the home (washing machine, toilet flushing systems)
- Increasing the pressure in domestic water systems



'AQUA SENSOR' PUMPS

24 HOUR ROUND THE CLOCK PROTECTION



CARRY HANDLE

Sturdy and ergonomic carry handle with integral suspension eyelet for rapid operational readiness

PUMP HOUSING

The long-lasting pump housing made of impact-proof plastic with a stainless steel outer shell can be depended on to withstand the harshest treatment

LONG POWER CABLE

The extra-long connection cable (10 m) enables the pump to be used for very deep immersion depths too

'Aqua Sensor' Clear Water Pump
GE-SP 4390 N-ALL ECO



HOSE CONNECTION

Universal connection is easily accessible on the top of the pump

PATENTED SENSOR SETTING

User-friendly setting of the three sensor starting heights or the continuous operation function



INTEGRAL AQUA SENSOR

The integral aqua sensor means that the pump has a slimline design, so it can be used in constricted spaces, e.g. in shafts

'AQUA SENSOR' CLEAR WATER PUMP



GE-SP 4390 N-ALL ECO	
EXPERT	
Mains voltage	230 V ~ 50 Hz
Rated input	430 W
Max. delivery capacity / height	9000 l/h / 8 m
Max. immersion depth	7 m
Max. size of foreign particle	1 mm
Pump start during continuous operation	5 mm
Sensor starting height 1	5 mm
Sensor starting height 2	56 mm
Sensor starting height 3	103 mm
Works in shallow clean water as low as	1 mm
Hose connection	47.8 mm (1½") ET
Power cord	10 m
Product weight	4.9 kg
Aqua Sensor Technology	•
Permanent mode without sensor start	•
Non-return valve	•
High-quality mechanical seal	•
Integrated cable rewind	-
Carry handle	•
Lifting eye	•
ECO Power	•
Universal hose adapter	•
Article number	41.714.40



'AQUA SENSOR' DIRTY WATER PUMPS



	GE-DP 7935 N-A ECO EXPERT	GE-DP 6935 A ECO EXPERT
Mains voltage	230 V ~ 50 Hz	230 V ~ 50 Hz
Rated input	790 W	690 W
Max. delivery capacity / height	19000 l/h / 9 m	17500 l/h / 9 m
Max. immersion depth	7 m	7 m
Max. size of foreign particle	35 mm	35 mm
Pump start during continuous operation	50 mm	50 mm
Sensor starting height 1	70 mm	70 mm
Sensor starting height 2	135 mm	135 mm
Sensor starting height 3	188 mm	188 mm
Suction down to	40 mm	40 mm
Hose connection	47.8 mm (1½") ET	47.8 mm (1½") ET
Power cord	10 m	10 m
Product weight	6.2 kg	5.7 kg
Aqua Sensor Technology	•	•
Permanent mode without sensor start	•	•
Non-return valve	•	•
High-quality mechanical seal	•	•
Integrated cable rewind	•	•
Carry handle	•	•
Lifting eye	•	•
ECO Power	•	•
Universal hose adapter	•	•
Article number	41.714.60	41.714.50



PATENTED AQUA SENSOR TECHNOLOGY

User-friendly setting of the three sensor starting heights or the continuous operation function.

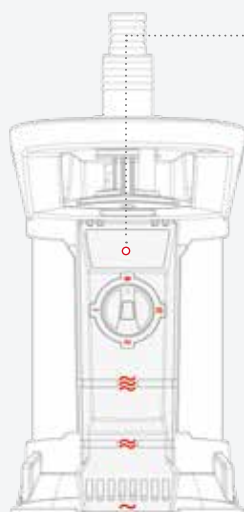

	AQUA SENSOR DIRTY WATER	AQUA SENSOR CLEAR WATER
Continuous operation (ON/OFF) without sensor circuit pump start		
•	50 mm	5 mm
Automatic sensor start		
•	188 mm	103 mm
Automatic sensor start		
•	135 mm	56 mm
Automatic sensor start		
•	70 mm	5 mm

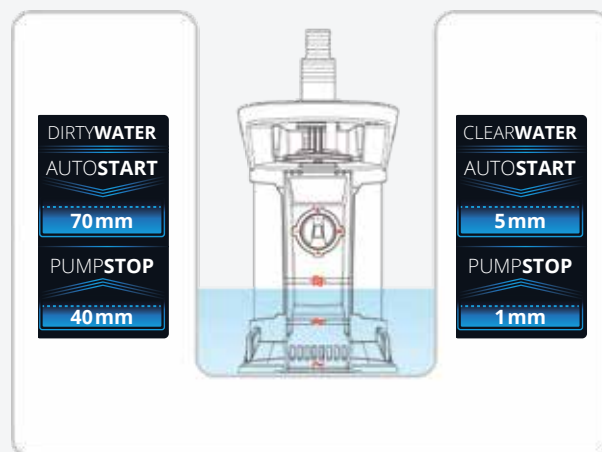

2-IN-1 MULTI-PURPOSE PUMPS

FLOAT SWITCH

The practical float switch serves for an automatic level control of the waste water and is infinitely adjustable

UNIVERSAL HOSE CONNECTOR

Easily accessible universal hose connector at the top side of the pump

2-IN-1 FUNCTION

Evacuation of clear water and wastewater with only one pump

2-in-1 Multi-Purpose Pump
GE-DP 7330 LL ECO



CARRY HANDLE

Sturdy and ergonomic carry handle with an integrated suspension eye for a quick operational readiness

PUMP HOUSING

Robust pump housing of impact-resistant plastic with a stainless steel outer skin withstands even the highest stress

PATENTED SUCTION LEVEL CONTROL

With the patented suction level control, a quick adaptation of the desired function (clear water operation or dirt water operation) can take place via a simple rotary motion at the pump foot



2-IN-1 MULTI-PURPOSE PUMPS



	GE-DP 7330 LL ECO EXPERT	GE-DP 5220 LL ECO EXPERT	GC-DP 7035 LL CLASSIC
Mains voltage	230 V ~ 50 Hz	230 V ~ 50 Hz	230 V ~ 50 Hz
Rated input	730 W	520 W	700 W
Max. delivery capacity / height	16500 l/h / 8.5 m	13500 l/h / 7.5 m	16000 l/h / 8 m
Max. immersion depth	7 m	7 m	7 m
Max. size of foreign particle	30 mm	20 mm	35 mm
Works in shallow clean water as low as	1 mm	1 mm	1 mm
Starting of pump from water level of	10 mm	10 mm	10 mm
Hose connection	47.8 mm (1½") ET	47.8 mm (1½") ET	47,8 mm (1½") AG
Power cord	10 m	10 m	10 m
Product weight	6.2 kg	5.4 kg	4.45 kg
Patented suction level control	•	•	•
High-quality mechanical seal	•	•	•
Floating switch (automatic and manual mode)	•	•	•
Integrated cable rewind	•	•	•
ECO Power	•	•	-
Carry handle with integrated lifting eye	•	•	•
Universal hose adapter	•	•	•
Article number	41.707.90	41.707.80	41.815.70



4 006825 598827



4 006825 598780



4 006825 660289

2-IN-1 MULTI-PURPOSE PUMPS

- 1 When the clear water function is activated: The pump starts when the water level is just 10 mm, and not many pumps can do that – plus it works in shallow water as low as 1 mm, i.e. just a quick wipe over at the end and the flooding is quickly forgotten
- 2 When the dirty water function is activated: Even large particles of dirt such as stones and lumps of sludge with diameters up to 20/30/35 mm (depending on the model) can be suctioned up without difficulty
- 3 2-in-1 function: Evacuation of clear water and wastewater with only one pump!
- 4 Patented suction level control: a simple rotary motion at the pump foot switches the function to suctioning for either shallow clear water or dirty water with large foreign particles



SUBMERSIBLE PUMPS DIRTY/CLEAR WATER 'ECO'



	GE-DP 7935 N ECO EXPERT	GE-DP 6935 ECO EXPERT	GE-DP 3925 ECO EXPERT	GE-SP 4390 LL ECO EXPERT
Suitable for	dirty water	dirty water	dirty water	clear water
Mains voltage	230 V ~ 50 Hz	230 V ~ 50 Hz	230 V ~ 50 Hz	230 V ~ 50 Hz
Rated input	790 W	690 W	390 W	430 W
Max. delivery capacity / height	20000 l/h / 9 m	17500 l/h / 9 m	10000 l/h / 6 m	9000 l/h / 8 m
Max. immersion depth	7 m	7 m	7 m	7 m
Min. water level for pump start	50 mm	50 mm	50 mm	5 mm
Works in shallow clean water as low as	-	-	-	1 mm
Max. size of foreign particle	35 mm	35 mm	25 mm	1 mm
Hose connection	47.8 mm (1½") ET	47.8 mm (1½") ET	47.8 mm (1½") ET	47.8 mm (1½") ET
Power cord	10 m	10 m	10 m	10 m
Product weight	7.3 kg	5.5 kg	4.5 kg	4.5 kg
Integrated lifting eye	•	•	•	•
High-quality mechanical seal	•	•	•	•
Floating switch (automatic and manual mode)	•	•	•	•
Integrated cable rewind	•	•	•	-
ECO Power	•	•	•	•
Carry handle	•	•	•	•
Non-return valve	-	-	-	•
Universal hose adapter	•	•	•	•
Article number	41.707.00	41.707.20	41.707.10	41.707.15



DIRTY WATER PUMPS



	GC-DP 1340 G CLASSIC	GE-DP 900 Cut EXPERT NEW	GC-DP 5010 G CLASSIC	GC-DP 9035 N CLASSIC
Mains voltage	230 V ~ 50 Hz	230 V ~ 50 Hz	220 - 240 V ~ 50 Hz	220 - 240 V ~ 50 Hz
Rated input	1300 W	900 W	500 W	900 W
Max. delivery capacity / height	23000 l/h / 10 m	16000 l/h / 11.5 m	12000 l/h / 8 m	18000 l/h / 9 m
Max. immersion depth	5 m	7 m	5 m	5 m
Max. size of foreign particle	40 mm	-	10 mm	35 mm
Hose connection	59.6 mm (2") IT	59.6 mm (2") IT	42 mm (1¼") IT	47.8 mm (1½") IT
Power cord	10 m	10 m	10 m	10 m
Product weight	22.0 kg	17.0 kg	10.6 kg	6.0 kg
Integrated lifting eye	-	-	-	-
High-quality mechanical seal	•	•	•	•
Floating switch	Automatic mode	Automatic mode	Automatic mode	Automatic and manual mode
Integrated cable rewind	-	-	-	-
Carry handle	•	•	•	•
Cutting unit system	-	•	-	-
Universal hose adapter	•	•	•	•
Lowering rope	• (6 m)	-	-	-
Article number	41.707.42	41.815.50	41.714.21	41.707.78



DIRTY WATER PUMPS



	GC-DP 9040 N CLASSIC	GC-DP 7835 CLASSIC	GC-DP 6315 N CLASSIC
Mains voltage	230 V ~ 50 Hz	230 V ~ 50 Hz	230 V ~ 50 Hz
Rated input	900 W	780 W	630 W
Max. delivery capacity / height	22000 l/h / 9 m	15700 l/h / 8 m	17000 l/h / 8 m
Max. immersion depth	7 m	7 m	5 m
Max. size of foreign particle	40 mm	35 mm	15 mm
Hose connection	50 mm (2") IT	47.8 mm (1½") IT	47.8 mm (1½") IT
Power cord	10 m	10 m	10 m
Product weight	7.5 kg	5.2 kg	4.7 kg
Integrated lifting eye	-	-	-
High-quality mechanical seal	•	•	•
Floating switch (automatic and manual mode)	•	•	•
Integrated cable rewind	•	•	•
Carry handle	•	•	•
Cutting unit system	-	-	-
Universal hose adapter	•	•	•
Lowering rope	-	-	-
Article number	41.815.10	41.706.82	41.704.91



DIRTY WATER PUMPS



	GC-DP 5225 N CLASSIC	GC-DP 3325 CLASSIC
Mains voltage	230 V ~ 50 Hz	230 V ~ 50 Hz
Rated input	520 W	330 W
Max. delivery capacity / height	10000 l/h / 7 m	9500 l/h / 6 m
Max. immersion depth	5 m	5 m
Max. size of foreign particle	25 mm	25 mm
Hose connection	47.8 mm (1½") IT	47.8 mm (1½") IT
Power cord	10 m	10 m
Product weight	4.1 kg	3.6 kg
Integrated lifting eye	-	-
High-quality mechanical seal	•	•
Floating switch (automatic and manual mode)	•	•
Integrated cable rewind	•	-
Carry handle	•	• (folding)
Cutting unit system	-	-
Universal hose adapter	•	•
Lowering rope	-	-
Article number	41.704.81	41.815.30



CLEAR WATER PUMPS



CLEAR WATER PUMPS



	GE-SP 750 LL EXPERT	GC-SP 5511 IF CLASSIC
Mains voltage	230 V ~ 50 Hz	230 V ~ 50 Hz
Rated input	750 W	550 W
Max. delivery capacity / height	15000 l/h / 10 m	11000 l/h / 8.5 m
Max. immersion depth	5 m	7 m
Hose connection	42 mm (1½") ET	47.8 mm (1½") IT
Power cord	10 m	10 m
Min. water level for pump start	50 mm	60 mm
Suction down to	2 mm	5 mm
Product weight	6.2 kg	4.4 kg
High-quality mechanical seal	•	-
Integ. float switch (auto. + manual mode)	•	•
Floating switch (automatic and manual mode)	-	-
Integrated cable rewind	•	-
Carry handle	•	•
Universal hose adapter	•	•
Article number	41.706.66	41.704.63



CLEAR WATER PUMPS



	GC-SP 3580 LL CLASSIC	GC-SP 2275 CLASSIC
Mains voltage	230 V - 50 Hz	230 V - 50 Hz
Rated input	350 W	220 W
Max. delivery capacity / height	8000 l/h / 7.5 m	7500 l/h / 6 m
Max. immersion depth	7 m	5 m
Hose connection	47.8 mm (1½") IT	47.8 mm (1½") IT
Power cord	10 m	10 m
Min. water level for pump start	8 mm	-
Suction down to	1 mm	8 mm
Product weight	3.1 kg	3.4 kg
High-quality mechanical seal	•	•
Integ. float switch (auto. + manual mode)	-	-
Floating switch (automatic and manual mode)	•	•
Integrated cable rewind	•	-
Carry handle	•	• (folding)
Universal hose adapter	•	•
Article number	41.704.45	41.815.20



RAIN BARREL PUMP



	GE-SP 3546 RB EXPERT
Mains voltage	230 V - 50 Hz
Rated input	350 W
Max. delivery capacity / height	4600 l/h / 11 m
Max. immersion depth	7 m
Max. size of foreign particle	2.5 mm
Hose connection	26.4 mm (¾") ET
Power cord	10 m
Suction down to	-
Product weight	5.0 kg
High-quality mechanical seal	-
Floating switch (infinitely variable)	•
Integrated cable rewind	•
Carry handle	•
Flexible gooseneck	•
Storage compartment for extensions	•
Universal hose adapter	-
Article number	41.704.38



**CLEAR WATER +
RAIN BARREL
PUMPS**
NOW ALSO COME IN
**RECHARGEABLE
BATTERY VERSION.**
READ MORE ON P. 49/50

SUBMERSIBLE PRESSURE PUMPS DEEP WELL PUMPS



AUTOMATIC FUNCTION

The equipment switches on automatically when water is required and then off again

4-STAGE IMPELLER SYSTEM

The impeller system is of 4-stage design and therefore supplies extra-high delivery pressure

HIGH-QUALITY MECHANICAL SEAL

The high-grade mechanical seal reduces friction and wear and therefore guarantees long service

HOSE CONNECTION WITH STAINLESS STEEL INSERT

The hose connection with stainless steel insert is really robust and long-lasting. Being ideally positioned for access at the top, it makes the pump suitable for use in constricted shafts

PUMP HOUSING

The long-lasting pump housing made of rust-proof stainless steel can be depended on to withstand the harshest treatment

Submersible Pressure Pump **GE-PP 1100 N-A**

SUBMERSIBLE PRESSURE PUMPS



Identical in construction



2-IN-1
SUBMERSIBLE PRESSURE PUMP + RAIN BARREL PUMP

	GE-PP 1100 N-A EXPERT	GC-PP 900 N CLASSIC	GE-PP 5555 RB-A EXPERT
Mains voltage	220 - 240 V ~ 50 Hz	230 V ~ 50 Hz	230 - 240 V ~ 50 Hz
Rated input	1100 W	900 W	550 W
Max. delivery capacity / height	6000 l/h / 45 m	6000 l/h / 32 m	5500 l/h / 20 m
Max. immersion depth	12 m	7 m	7 m
Max. size of foreign particle	-	-	-
Hose connection	33.3 mm (1") IT	33.3 mm (1") IT	33.3 mm (G1 ET)
Power cord	15 m	10 m	10 m
Product weight	8.7 kg	8.9 kg	5.0 kg
Automatic mode	•	-	•
Floating switch	-	•	-
Dry operation protection	•	-	•
Multi-stage pump impeller	• (4 pcs)	• (3 pcs)	• (2 pcs)
High-quality mechanical seal	•	•	•
Overload cut-out	•	•	•
Integrated non-return valve	•	-	•
Stainless dirt screen	•	-	-
High-quality INOX high-grade steel pump housing	•	•	-
Integrated cable rewind	-	-	•
Carry handle	•	-	•
Telescopic extension tube	-	-	•
Flexible gooseneck	-	-	•
Article number	41.714.30	41.709.64	41.704.25



4 006825 622294



4 006825 597752



4 006825 648690

DEEP WELL PUMPS



	GE-DW 1155 N-A EXPERT NEW	GC-DW 1300 N CLASSIC	GC-DW 1045 N CLASSIC
Mains voltage	220 - 240 V ~ 50 Hz	230 V ~ 50 Hz	220 - 240 V ~ 50 Hz
Rated input	1100 W	1300 W	1000 W
Max. delivery capacity / height	6000 l/h / 55 m	5000 l/h / 65 m	6500 l/h / 45 m
Max. immersion depth	19 m	20 m	19 m
Max. size of foreign particle	-	-	-
Hose connection	33.3 mm (1") IT	47.8 mm (1½") IT	42 mm (1¼") IT
Power cord	22 m	2 m / 23 m	22 m
Pump diameter	98 mm	102 mm	98 mm
Product weight	9.8 kg	15.5 kg	7.7 kg
Automatic mode	•	-	-
Dry operation protection	•	-	-
Multi-stage pump impeller	• (8 pcs)	• (10 pcs)	• (6 pcs)
High-quality mechanical seal	•	•	•
Overload cut-out	•	•	•
Integrated non-return valve	•	•	•
Stainless dirt screen	•	•	•
High-quality INOX high-grade steel pump housing	•	•	•
External switchbox	-	•	-
Lowering rope	• (22 m)	• (20 m)	• (22 m)
Article number	41.709.37	41.709.44	41.709.55



4 006825 660876



4 006825 597875



4 006825 616446



SURFACE PUMPS 'PLUS'

**EASY PUMPING.
WITH THE NEW SURFACE PUMP GENERATION FROM EINHELL.**

■ INNOVATIVE FEATURES

- Fast and easy installation as well as quick error detection thanks to status indicators
- Long life, low maintenance and exceptional protection thanks to special safety mechanisms

■ HIGHER PERFORMANCE BY LESS ENERGY CONSUMPTION

The new **Garden Pumps 'PLUS'**, **Automatic Domestic Water Systems 'PLUS'** and **Water Works 'PLUS'** concept consists of 2 parts:

1. STATUS INDICATORS

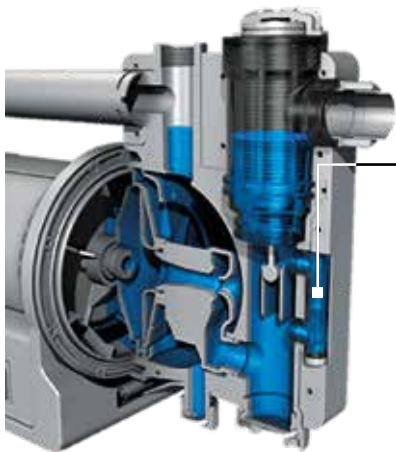

EXPERT Version

■ WATER FILLING INDICATOR

Before starting-up the pump for the first time it needs to be filled with water to secure a flawless intake procedure. Thanks to the sight glass the customer can see at first sight if there is already enough water filled into the pump.

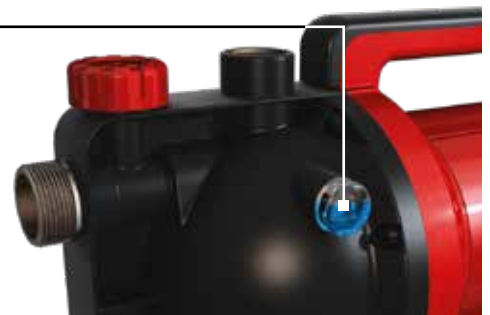

CLASSIC Version

■ PRE-FILTER

Easy to clean and easy to change for optimal pump performance.



■ BIG WATER FILLER SCREW

Big water filler opening through which it is very easy to fill water into the pump.



■ SUCTION INDICATOR

The suction pressure gauge in the cover of the water filling opening provides information about the suction height/suction pressure and any possible suction problems.

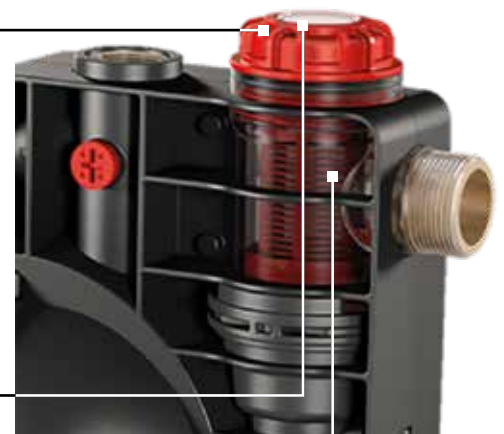

■ DIRT INDICATOR

Due to transparent material around the pre filter it can easily be seen if the filter is dirty and needs to be cleaned or even replaced by a new one.

FEATURE SEGMENTATION

	EXPERT	CLASSIC
Garden Pumps	GE-GP 1145 ECO GE-GP 1246 N FS	GC-GP 6040 ECO GC-GP 8042 ECO GC-GP 1045 GC-GP 1250 N
Automatic Home and Garden Pumps	GE-AW 1042 FS GE-AW 1246 N FS	–
Water Works	GE-WW 1145 ECO GE-WW 1246 N FS	GC-WW 8042 ECO GC-WW 1045 N

STATUS INDICATORS

Water Filling Indicator*	•	•
Suction Indicator*	•	–
Dirt Indicator (Pre-filter with non-return valve)	•	–

SAFETY + PREVENTION

Flow Sensor	• (excluded GE-GP/WW 1145 ECO)	–
Dry Running Protection	• (excluded GE-GP/WW 1145 ECO)	–
Scalding Protection	• (excluded GE-GP/WW 1145 ECO)	–
Thermo Protection	•	•
Frost Protection	•	•

* Patent pending

2. SAFETY AND PREVENTION**SCALDING PROTECTION**



If there is a blockage on the pressure side and the pump continues working, the water that remains in the pump will get hot. To prevent the customer from scalding himself with the hot water when checking the pump, the scalding protection shuts off the pump.

FROST PROTECTION – WATER DRAIN SCREW

Often customers forget to empty the pump before winter and the frozen water destroys the pump. To hinder the water to freeze there is a convenient water drain screw with which the water can be released very quick.

WATER FLOW RECOGNITION SENSOR

Sensor that measures the water flow (LEDs).

-  **Red:** Failure – no water in the pump
-  **Yellow:** Flow Detection
-  **Green:** Pump runs normal

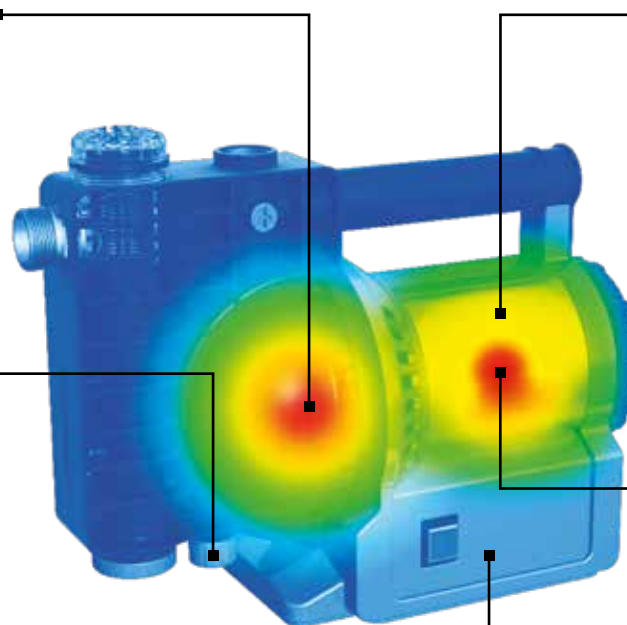
**DRY RUNNING PROTECTION**

If the pump is not able to suck water any more (e.g. empty water source) the dry running safety recognizes this and stops the pump. It tries to start the pump again and if there is still no water getting sucked it stops again and shuts off the pump. This prevents overheating of the pump and so a overheating of the engine.

THERMO PROTECTION

To prevent severe damages, the integrated thermo switch cuts off the pump when the engine overheats.



GARDEN PUMPS 'PLUS'

SUCTION INDICATOR
provides information about the suction height/suction pressure and any possible suction problems

HIGH-QUALITY THREAD
Long service life for the thread and pump

DIRT INDICATOR
It is easy to see whether the filter is dirty and may need cleaning

WATER FILLING INDICATOR
The window tells you at a glance whether and how much water has already been filled in the pump

FROST PROTECTION
The water drain screw makes it easy to completely drain the pump to make it safe from frost

ADDITIONAL PRESSURE CONNECTION
enables a number of consumers to be operated at the same time



Garden Pump 'Plus'
GE-GP 1246 N FS

DRY RUNNING AND SCALDING PROTECTION
The Flow Sensor measures the water flow permanently and thereby prevents damage to the pump

GARDEN PUMPS 'PLUS'



	GE-GP 1246 N FS EXPERT	GE-GP 1145 ECO EXPERT
Mains voltage	220 - 240 V ~ 50 Hz	220 - 240 V ~ 50 Hz
Rated input	1200 W	1100 W
Max. delivery capacity / height	4600 l/h / 50 m	4500 l/h / 48 m
Max. suction height	8 m	8 m
Suction connection	42 mm (1 1/4") ET	42 mm (1 1/4") ET
Pressure connection	33.3 mm (1") IT	33.3 mm (1") IT
Additional pressure side connection	33.3 mm (1") IT	33.3 mm (1") IT
Power cord	1.5 m	1.5 m
Product weight	14.0 kg	14.0 kg
Water filler screw	•	•
Water filling / dirt / suction indicators	• / • / •	• / • / •
Integrated pre-filter with non-return valve	•	•
Carry handle	Comfort	Comfort
Frost protection due to a water drain screw	•	•
Thermo protection	•	•
Water flow recognition sensor / dry running protection / scalding protection	• / • / •	- / - / -
ECO Power	-	•
Incl. adapter 33.3 mm (1") ET	•	•
Article number	41.803.60	41.803.70



GARDEN PUMPS 'PLUS'



	GC-GP 1250 N CLASSIC	GC-GP 1045 CLASSIC
Mains voltage	220 - 240 V ~ 50 Hz	220 - 240 V ~ 50 Hz
Rated input	1200 W	1050 W
Max. delivery capacity / height	5000 l/h / 50 m	4500 l/h / 48 m
Max. suction height	8 m	8 m
Suction connection	42 mm (1 1/4") ET	42 mm (1 1/4") ET
Pressure connection	33.3 mm (1") IT	33.3 mm (1") IT
Additional pressure side connection	-	-
Power cord	1.5 m	1.5 m
Product weight	9.7 kg	9.5 kg
Water filler screw	•	•
Water filling / dirt / suction indicators	• / - / -	• / - / -
Integrated pre-filter with non-return valve	-	-
Carry handle	Comfort	Comfort
Frost protection due to a water drain screw	•	•
Thermo protection	•	•
ECO Power	-	-
Incl. adapter 33.3 mm (1") ET	•	•
Article number	41.803.50	41.803.40



4 006825 637281



4 006825 637274

GARDEN PUMPS 'PLUS'



	GC-GP 8042 ECO CLASSIC	GC-GP 6040 ECO CLASSIC
Mains voltage	220 - 240 V ~ 50 Hz	220 - 240 V ~ 50 Hz
Rated input	800 W	600 W
Max. delivery capacity / height	4200 l/h / 43 m	4000 l/h / 36 m
Max. suction height	8 m	8 m
Suction connection	42 mm (1 1/4") ET	42 mm (1 1/4") ET
Pressure connection	33.3 mm (1") IT	33.3 mm (1") IT
Additional pressure side connection	-	-
Power cord	1.5 m	1.5 m
Product weight	8.2 kg	6.1 kg
Water filler screw	•	•
Water filling / dirt / suction indicators	• / - / -	• / - / -
Integrated pre-filter with non-return valve	-	-
Carry handle	Foldable	Foldable
Frost protection due to a water drain screw	•	•
Thermo protection	•	•
ECO Power	•	•
Incl. adapter 33.3 mm (1") ET	•	•
Article number	41.803.30	41.803.20



4 006825 637267



4 006825 637250

GARDEN PUMPS



	GC-GP 1250 N <i>CLASSIC</i>	GC-GP 1046 N <i>CLASSIC</i>
Mains voltage	220 - 240 V ~ 50 Hz	220 - 240 V ~ 50 Hz
Rated input	1200 W	1050 W
Max. delivery capacity / height	5000 l/h / 50 m	4600 l/h / 48 m
Max. suction height	8 m	8 m
Suction connection	42 mm (1 1/4") ET	42 mm (1 1/4") ET
Pressure connection	33.3 mm (1") IT	33.3 mm (1") IT
Power cord	1.5 m	1.5 m
Product weight	9.8 kg	9.6 kg
Water filler screw	•	•
Water drain screw	•	•
High-quality mechanical seal	•	•
Prefilter with integrated non-return valve	-	-
Carry handle	•	•
Suction hose included	-	-
Article number	41.814.60	41.814.50



GARDEN PUMPS
NOW ALSO COME IN RECHARGEABLE BATTERY VERSION
READ MORE ON P. 48



GARDEN PUMPS



	GC-GP 6538 CLASSIC	GC-GP 6538 Set CLASSIC	GC-GP 6538 Set/I CLASSIC
Mains voltage	220 - 240 V ~ 50 Hz	220 - 240 V ~ 50 Hz	220 - 240 V ~ 50 Hz
Rated input	650 W	650 W	650 W
Max. delivery capacity / height	3800 l/h / 36 m	3800 l/h / 36 m	3800 l/h / 36 m
Max. suction height	8 m	8 m	8 m
Suction connection	33.3 mm (1") ET	33.3 mm (1") ET	33.3 mm (1") ET
Pressure connection	33.3 mm (1") ET	33.3 mm (1") ET	33.3 mm (1") IT
Power cord	1.4 m	1.4 m	1.4 m
Product weight	6.1 kg	6.1 kg	6.1 kg
Water filler screw	•	•	•
Water drain screw	•	•	•
High-quality mechanical seal	•	•	•
Prefilter with integrated non-return valve	-	-	-
Carry handle	•	•	•
Suction hose included	-	• (7 m)	• (4 m)
Article number	41.802.80	41.802.83	41.802.86



4 006825 603477



4 006825 611168



4 006825 638875

GARDEN PUMPS



	GC-GP 6036 CLASSIC	GC-TP 4622 CLASSIC
Mains voltage	230 V ~ 50 Hz	220 - 240 V ~ 50 Hz
Rated input	600 W	460 W
Max. delivery capacity / height	3600 l/h / 40 m	2250 l/h / 37 m
Max. suction height	8 m	-
Suction connection	33.3 mm (1") IT	33.3 mm (1") IT
Pressure connection	33.3 mm (1") IT	33.3 mm (1") IT
Power cord	1.5 m	1.5 m
Product weight	9.5 kg	6.1 kg
Water filler screw	•	•
Water drain screw	•	•
High-quality mechanical seal	-	-
Prefilter with integrated non-return valve	-	-
Carry handle	•	-
Suction hose included	-	-
Article number	41.802.69	41.834.00



4 006825 623567



4 006825 643947

AUTOMATIC HOME AND GARDEN PUMPS 'PLUS'

SUCTION INDICATOR

provides information about the suction height/suction pressure and any possible suction problems

HIGH-QUALITY THREADS

Long service life for the threads and pump

DIRT INDICATOR

It is easy to see whether the filter is dirty and may need cleaning

WATER FILLING INDICATOR

The window tells you at a glance whether and how much water has already been filled in the pump

FROST PROTECTION

The water drain screw makes it easy to completely drain the pump to make it safe from frost

ADDITIONAL PRESSURE CONNECTION

enables a number of consumers to be operated at the same time

DRY RUNNING AND SCALDING PROTECTION

The Flow Sensor measures the water flow permanently and thereby prevents damage to the pump



Automatic Home and Garden Pump 'Plus' GE-AW 1042 FS

LED DISPLAY

The LED display provides at-a-glance information about the status of the pump

AUTOMATIC HOME AND GARDEN PUMPS 'PLUS'



	GE-AW 1246 N FS EXPERT	GE-AW 1042 FS EXPERT
Mains voltage	220 - 240 V ~ 50 Hz	220 - 240 V ~ 50 Hz
Rated input	1200 W	1050 W
Max. delivery capacity / height	4600 l/h / 50 m	4200 l/h / 48 m
Max. pressure	5.0 bar	4.8 bar
Max. suction height	8 m	8 m
Suction connection	42 mm (1 1/4") ET	42 mm (1 1/4") ET
Pressure connection	33.3 mm (1") IT	33.3 mm (1") IT
Additional pressure side connection	33.3 mm (1") IT	33.3 mm (1") IT
Power cord	1.5 m	1.5 m
Product weight	15.0 kg	15.0 kg
Automatic mode	•	•
Timer function	•	-
Water filler screw	•	•
Water filling / dirt / suction indicators	• / • / •	• / • / •
Integrated pre-filter with non-return valve	•	•
Carry handle	Comfort	Comfort
Frost protection due to a water drain screw	•	•
Thermo protection	•	•
Water flow recognition sensor / dry running protection / scalding protection	• / • / •	• / • / •
Incl. adapter 33.3 mm (1") ET	•	•
Article number	41.770.20	41.770.10



4 006825 642476



4 006825 642469

AUTOMATIC HOME AND GARDEN PUMPS



	GC-AW 9036 CLASSIC	GC-AW 6333 CLASSIC
Mains voltage	230 V ~ 50 Hz	230 V ~ 50 Hz
Rated input	900 W	630 W
Max. delivery capacity / height	3600 l/h / 43 m	3300 l/h / 36 m
Max. pressure	4.3 bar	3.6 bar
Max. suction height	7 m	8 m
Suction connection	42 mm (1½") ET	42 mm (1½") ET
Pressure connection	33.3 mm (1") IT	33.3 mm (1") IT
Power cord	1.5 m	1.5 m
Product weight	9.9 kg	7.8 kg
Automatic mode	•	•
Timer function	-	-
Dry running protection	•	•
Indicator	LED	LED
Water filler screw	•	•
Water drain screw	•	•
ECO Power	-	-
Prefilter with integrated non-return valve	•	•
Carry handle	•	•
Article number	41.767.20	41.767.30



4 006825 601954



4 006825 609226



WATER WORKS 'PLUS'

SUCTION INDICATOR

provides information about the suction height/suction pressure and any possible suction problems

HIGH-QUALITY THREADS

Long service life for the thread and pump

DIRT INDICATOR

It is easy to see whether the filter is dirty and may need cleaning

WATER FILLING INDICATOR

The window tells you at a glance whether and how much water has already been filled in the pump

FROST PROTECTION

The water drain screw makes it easy to completely drain the pump to make it safe from frost

ADDITIONAL PRESSURE CONNECTION
enables a number of consumers to be operated at the same time



Water Work 'Plus'
GE-WW 1145 ECO

INTEGRATED PRESSURE GAUGE
It provides at-a-glance information about the current pressure

20 L TANK
Large Tank for a permanent supply of water

WATER WORKS 'PLUS'

**20 l
TANK**

	GE-WW 1246 N FS EXPERT	GE-WW 1145 ECO EXPERT
Mains voltage	220 - 240 V ~ 50 Hz	220 - 240 V ~ 50 Hz
Rated input	1200 W	1100 W
Max. delivery capacity / height	4600 l/h / 50 m	4500 l/h / 48 m
Max. suction height	8 m	8 m
Suction connection	42 mm (1 1/4") ET	42 mm (1 1/4") ET
Pressure connection	33.3 mm (1") IT	33.3 mm (1") IT
Additional pressure side connection	33.3 mm (1") IT	33.3 mm (1") IT
Tank volume	20 l	20 l
Max. activation / cut off pressure	1.5 bar / 3 bar	1.5 bar / 3 bar
Power cord	1.5 m	1.5 m
Product weight	19.5 kg	19.5 kg
Water filler screw	•	•
Water filling / dirt / suction indicators	• / • / •	• / • / •
Integrated pre-filter with non-return valve	•	•
Carry handle	Comfort	Comfort
Frost protection due to a water drain screw	•	•
Thermo protection	•	•
Water flow recognition sensor / dry running protection / scalding protection	• / • / •	- / - / -
Incl. adapter 33.3 mm (1") ET	•	•
Article number	41.735.30	41.735.40



WATER WORKS 'PLUS'

**PRESSURE
GAUGE**

	GC-WW 1045 N CLASSIC	GC-WW 8042 ECO CLASSIC
Mains voltage	220 - 240 V ~ 50 Hz	220 - 240 V ~ 50 Hz
Rated input	1050 W	800 W
Max. delivery capacity / height	4500 l/h / 48 m	4200 l/h / 43 m
Max. suction height	8 m	8 m
Suction connection	42 mm (1 1/4") ET	42 mm (1 1/4") ET
Pressure connection	33.3 mm (1") IT	33.3 mm (1") IT
Additional pressure side connection	-	-
Tank volume	20 l	20 l
Max. activation / cut off pressure	1.5 bar / 3 bar	1.5 bar / 3 bar
Power cord	1.5 m	1.5 m
Product weight	17.3 kg	13.3 kg
Water filler screw	•	•
Water filling / dirt / suction indicators	• / - / -	• / - / -
Integrated pre-filter with non-return valve	-	-
Carry handle	Comfort	Foldable
Frost protection due to a water drain screw	•	•
Thermo protection	•	•
Incl. adapter 33.3 mm (1") ET	•	•
Article number	41.735.20	41.735.10



WATER WORKS



	GC-WW 1250 NN CLASSIC	GC-WW 1046 N CLASSIC
Mains voltage	220 - 240 V ~ 50 Hz	220 - 240 V ~ 50 Hz
Rated input	1200 W	1050 W
Max. delivery capacity / height	5000 l/h / 50 m	4600 l/h / 48 m
Max. suction height	8 m	8 m
Tank volume	20 l	20 l
Max. activation / cut off pressure	1.5 bar / 3 bar	1.5 bar / 3 bar
Suction connection	42 mm (1½") ET	42 mm (1½") ET
Pressure connection	33.3 mm (1") IT	33.3 mm (1") IT
Power cord	1.5 m	1.5 m
Product weight	14.7 kg	14.4 kg
Overload protection	•	•
Water filler screw	•	•
Water drain screw	•	•
High-quality mechanical seal	•	•
INOX stainless steel pressure tank	•	-
Prefilter with integrated non-return valve	-	-
Pressure gauge	•	•
Suction hose included	-	-
Article number	41.734.90	41.734.80



WATER WORKS



	GC-WW 6538 CLASSIC	GC-WW 6538 Set CLASSIC	GC-WW 6036 CLASSIC
Mains voltage	220 - 240 V ~ 50 Hz	220 - 240 V ~ 50 Hz	230 V ~ 50 Hz
Rated input	650 W	650 W	600 W
Max. delivery capacity / height	3800 l/h / 36 m	3800 l/h / 36 m	3600 l/h / 40 m
Max. suction height	8 m	8 m	8 m
Tank volume	20 l	20 l	20 l
Max. activation / cut off pressure	1.5 bar / 3 bar	1.5 bar / 3 bar	1.5 bar / 3 bar
Suction connection	33.3 mm (1") ET	33.3 mm (1") ET	33.3 mm (1") IT
Pressure connection	33.3 mm (1") ET	33.3 mm (1") ET	33.3 mm (1") IT
Power cord	1.4 m	1.4 m	1.5 m
Product weight	10.5 kg	10.5 kg	14.3 kg
Overload protection	•	•	•
Water filler screw	•	•	•
Water drain screw	•	•	-
High-quality mechanical seal	•	•	-
Pressure gauge	•	•	•
Suction hose included	-	7 m	-
Article number	41.731.90	41.731.93	41.731.18



PETROL WATER PUMPS



	GE-PW 46 EXPERT	GC-PW 16 CLASSIC
Engine	Four-stroke	Four-stroke
Power rating	4.6 kW / 6.3 hp	1.6 kW / 2.2 hp
Max. delivery capacity / height	23000 l/h / 26 m	14000 l/h / 28 m
Max. suction height	6.5 m	7.0 m
Max. speed	3600 min ⁻¹	3600 min ⁻¹
Suction connection	59.6 mm (2") ET	47.8 mm (1½") ET
Pressure connection	59.6 mm (2") ET	47.8 mm (1½") ET
Fuel tank capacity	3.6 l	1.8 l
Product weight	23.0 kg	11.2 kg
Non-return valve	•	•
Sturdy steel tube frame	•	-
Water filler port	•	•
Water drain screw	•	•
Oil filling screw	•	•
Low oil stop	•	•
Incl. hose adapter	2x 50.8 mm (2")	2x 38.1 mm (1.5")
Incl. intake cage	• (2")	• (1.5")
Incl. reducer section	2x 47.8 mm (1.5") ET, 2x 33.3 mm (1") ET	-
Article number	41.713.72	41.905.30



ACCESSORIES + SPARE PARTS



SURFACE PUMPS ACCESSORIES



	Suction hose	Suction hose	Suction hose	Suction hose
Length	4 m	4 m	7 m	7 m
Connectors material	Brass	Plastic	Brass	Plastic
Connectors	42 mm (1¼") IT	42 mm (1¼") IT	42 mm (1¼") IT	42 mm (1¼") IT
Hose diameter	25 mm (1")	25 mm (1")	25 mm (1")	25 mm (1")
Threaded nipple	33.3 mm (1") ET	33.3 mm (1") ET	33.3 mm (1") ET	33.3 mm (1") ET
Adapter	-	33.3 mm (1") IT	-	33.3 mm (1") IT
Article number	41.736.30	41.736.35	41.736.40	41.736.45



4 006825 549133



4 006825 549058



4 006825 549171



4 006825 549102



	Coarse Filter 12 cm	NEW	Coarse Filter 25 cm	NEW
Height of filter insert	12 cm		25 cm	
Cartridge included	•		•	
Article number	41.738.01		41.738.51	



4 006825 549188



4 006825 549195











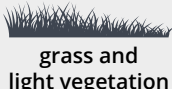

	Electronic Flow Switch
Max. operation pressure	10 bar
Max. water temperature	55 °C
Non-return valve	•
Integrated dry operation protection	•
Article number	41.742.21





4 006825 549225

SCYTHES/LAWN TRIMMERS ACCESSORIES



Cutting Tools



	Type designation	Suitable for	Hole	Material thickness	Ø	Fits	Article No.
	Special Grass Blade 230	 grass and light vegetation	25.4 mm	1.4 mm	230 mm		34.366.60
	Thicket Blade 255	 wild growth, scrub and thicket	25.4 mm	2.5 mm	255 mm		34.050.82
	Thicket Blade 200	 wild growth, scrub and thicket	25.4 mm	2.0 mm	200 mm		34.050.83
	Grass Blade 255	 tough grass and strong vegetation	25.4 mm	1.4 mm	255 mm		34.049.96
	Grass Blade 230	 tough grass and strong vegetation	25.4 mm	1.4 mm	230 mm		34.366.61



Line Spools

	Multifunctional Tools		Scythes							Lawn Trimmers						Article No.			
	GC-MM 52 I AS	GE-LM 36/4in1 Li	AGILLO 36/255 BL	AGILLO 18/200	GE-BC 43 AS	GC-BC 36-4 S	GC-BC 52 I AS	GH-BC 43 AS	GC-BC 30/1 AS	GC-BC 25/1 AS	GE-CT 36/30 Li E	GE-CT 18/30 Li	GE-CT 18/28 Li	GC-PT 2538/1 I AS	GC-ET 4530		GC-ET 3023	GC-ET 2522	
	•						•	•	•	•							•	34.050.75	
		•	•	•							•							•	34.050.86
													•						34.050.96
													•						34.051.16
												•							34.051.17
					•	•							•						34.052.20
														•					34.052.40
															•				34.056.85
																			34.056.90
																	•		34.056.95

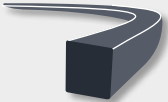
Mowing Lines

BASIC LINE	Colour	Description	Shape	Ø	Length	Article No.
	Grey	Standard mowing line		1.3 mm	15 m	34.366.50
				1.6 mm	15 m	34.366.51
				2.0 mm	15 m	34.366.52

SUPER CUT LINE	Colour	Description	Shape	Ø	Length	Article No.
	Black	Optimum cut thanks to sharp edges		2.0 mm	15 m	34.366.53
				2.4 mm	15 m	34.366.54
				3.0 mm	15 m	34.366.56

LOW NOISE LINE	Colour	Description	Shape	Ø	Length	Article No.
	Red	Reduced noise		2.4 mm	15 m	34.366.55
				3.0 mm	15 m	34.366.57

POWER X-CHANGE



ROBOT LAWN MOWERS

		FREELEVO 300 – Solo	FREELEVO 350	FREELEVO 400 BT	FREELEVO 450 BT – Solo	FREELEVO 500 BT	FREELEVO 500 LCD BT+	FREELEVO 600 BT	FREELEVO 750 LCD BT+	FREELEVO 800 LCD BT – Solo	FREELEVO 900 LCD BT	FREELEVO 1200 LCD BT
Power X-Change Battery 1.5 Ah	Not available separately – only as part of the Starter Kit	•	•									
Power X-Change Battery 2.0 Ah		•	•	•	•							
Power X-Change Battery 2.5 Ah		•	•	•	•	•	•	•				
Power X-Change Battery 3.0 Ah	Not available separately – only as part of the Starter Kit	•	•	•	•	•	•	•	•	•	•	
Power X-Change Plus Battery 3.0 Ah		•	•	•	•	•	•	•	•	•	•	
Power X-Change Battery 4.0 Ah		•	•	•	•	•	•	•	•	•	•	
Power X-Change Plus Battery 4.0 Ah	Available only as a Twinpack Set	•	•	•	•	•	•	•	•	•	•	
Power X-Change Plus Battery 5.2 Ah		•	•	•	•	•	•	•	•	•	•	•
Power X-Change Battery 4-6 Multi Ah		•	•	•	•	•	•	•	•	•	•	•
Power X-Change Battery 5-8 Multi Ah		•	•	•	•	•	•	•	•	•	•	•
Power X-Charger 3 A	Not available separately – only as part of the Starter Kit	•	•	•	•	•	•	•	•	•	•	•
Power X-Fastcharger 4 A		•	•	•	•	•	•	•	•	•	•	•
Power X-Twincharger 3 A		•	•	•	•	•	•	•	•	•	•	•
Power X-Boostcharger 6 A		•	•	•	•	•	•	•	•	•	•	•
Power X-Quattrocharger 4 A		•	•	•	•	•	•	•	•	•	•	•
Power X-Car Charger 6 A		•	•	•	•	•	•	•	•	•	•	•

Information provided in the Power X-Change accessories table shows the recommended rechargeable battery capacities for perfect results.

POWER X-CHANGE



SURFACE BRUSH
HEDGE TRIMMERS
MULTIFUNCTIONAL TOOLS

		PICOBELLA	GE-CH 36/65 Li	GE-CH 36/61 Li	GE-CH 18/60 Li	ARCURRA 18/55	GC-CH 1855/1 Li	GC-CH 1846 Li	GC-CH 18/40 Li	GE-IM 36/4in1 LiT	GE-HC 18 LiT
Power X-Change Battery 1.5 Ah	Not available separately – only as part of the Starter Kit	•	•	•	•	•	•	•	•	•	
Power X-Change Battery 2.0 Ah		•	•	•	•	•	•	•	•	•	
Power X-Change Battery 2.5 Ah		•	•	•	•	•	•	•	•	•	•
Power X-Change Battery 3.0 Ah	Not available separately – only as part of the Starter Kit	•	•	•	•	•	•	•	•	•	•
Power X-Change Plus Battery 3.0 Ah		•	•	•	•	•	•	•	•	•	•
Power X-Change Battery 4.0 Ah		•	•	•	•	•	•	•	•	•	•
Power X-Change Plus Battery 4.0 Ah	Available only as a Twinpack Set	•	•	•	•	•	•	•	•	•	•
Power X-Change Plus Battery 5.2 Ah		•	•	•	•	•	•	•	•	•	•
Power X-Change Battery 4-6 Multi Ah		•	•	•	•	•	•	•	•	•	•
Power X-Change Battery 5-8 Multi Ah		•	•	•	•	•	•	•	•	•	•
Power X-Charger 3 A	Not available separately – only as part of the Starter Kit	•	•	•	•	•	•	•	•	•	•
Power X-Fastcharger 4 A		•	•	•	•	•	•	•	•	•	•
Power X-Twincharger 3 A		•	•	•	•	•	•	•	•	•	•
Power X-Boostcharger 6 A		•	•	•	•	•	•	•	•	•	•
Power X-Quattrocharger 4 A		•	•	•	•	•	•	•	•	•	•
Power X-Car Charger 6 A		•	•	•	•	•	•	•	•	•	•

Information provided in the Power X-Change accessories table shows the recommended rechargeable battery capacities for perfect results.

POWER X-CHANGE CORDLESS / ELECTRIC / PETROL / MANUAL LAWN MOWERS

SPARE BLADES

COMBI-NATION BLADES

DIV.



Spare Blade	34.045.53	4006825 633092	
Spare Blade	34.054.10	4006825 649307	
Spare Blade	34.054.20	4006825 602661	
Spare Blade	34.054.30	4006825 595376	
Spare Blade	34.054.40	4006825 595369	
Spare Blade	34.054.51	4006825 610604	
Spare Blade	34.054.52	4006825 610611	
Spare Blade	34.054.53	4006825 645736	
Spare Blade	34.054.54	4006825 651386	
Spare Blade	34.054.55	4006825 631050	
Spare Blade	34.054.56	4006825 662702	
Spare Blade	34.054.85	4006825 584509	
Spare Blade	34.054.86	4006825 635843	
Spare Blade	34.056.05	4006825 541014	
Spare Blade	34.056.10	4006825 541038	
Spare Blade	34.056.60	4006825 605273	
Spare Blade	34.058.25	4006825 630466	
Spare Blade	34.058.30	4006825 630480	
Spare Blade	34.058.50	4006825 638806	
Combination Blade	34.056.50	4006825 605266	
Combination Blade	34.056.70	4006825 605280	
Grass Box	34.211.12	4006825 609707	

SCARIFIERS/AERATORS	DIV.		Catch Bag	34.055.76	4006825 608359	4	
AERATOR ROLLERS		Catch Bag	34.059.40	4006825 658798	4		
		Aerator Roller	34.055.71	4006825 608601	4		
		Aerator Roller	34.055.72	4006825 629675	4		
		Aerator Roller	34.059.41	4006825 658804	4		
		Aerator Roller	34.211.09	4006825 552942	4		
		Aerator Roller	34.211.25	4006825 575156	4		
		Aerator Roller	34.211.35	4006825 606331	4		
		Cutter Roller	34.055.81	4006825 608366	4		
		Cutter Roller	34.055.82	4006825 629682	4		
		Cutter Roller	34.059.42	4006825 658811	4		
CUTTER ROLLERS		Cutter Roller	34.200.21	4006825 603309	4		
		Cutter Roller	34.211.08	4006825 549201	4		
		Cutter Roller	34.211.20	4006825 575149	4		
		Cutter Roller	34.211.30	4006825 606324	4		
		Extension (1 m)	34.370.12	4006825 659054	4		
		Earth Auger (120 mm)	34.370.10	4006825 659030	4		
		Mortar Mixer	34.370.11	4006825 659047	4		
		Spare Blades Set for lawn trimmers (20 pcs)	34.057.30	4006825 560404	4		
		Spare Blades Box for PXC lawn trimmers (50 pcs)	34.057.36	4006825 646283	4		
		Spare Blade	34.051.01	4006825 653533	4		
EARTH AUGER		Spare Brush Steel (15 mm)	34.241.00	4006825 569919	4		
		Spare Brush Nylon (10 mm)	34.241.10	4006825 569926	4		
		Spare Brushes Steel (10 mm) and Nylon (6 mm) – one of each	34.241.15	4006825 660760	4		
		Surface Brush SOFT (wood/artificial turf)	34.241.21	4006825 646252	4		
LAWN TRIMMERS / LAWN EDGE TRIMMER		Surface Brush MEDIUM (stone)	34.241.20	4006825 646245	4		
		Surface Brush ULTRA (stone)	34.241.22	4006825 646269	4		
		Side Brush ULTRA (stone)	34.241.26	4006825 660845	4		
		Spare Chain	45.001.87	4006825 615463	4		
GROUT CLEANER		Spare Chain	45.001.88	4006825 606355	4		
		Spare Chain	45.003.64	4006825 644616	4		
		Spare Bar	45.001.17	4006825 569100	4		
		Spare Bar	45.001.67	4006825 615456	4		
SURFACE BRUSH		Spare Bar	45.001.68	4006825 606348	4		
		Spare Bar	45.001.68	4006825 606348	4		
		Spare Bar	45.003.63	4006825 644609	4		
		Spare Bar	45.003.63	4006825 644609	4		
POLE-MOUNTED PRUNERS / MULTIFUNCTIONAL TOOLS	CHAINS		Spare Bar	45.001.68	4006825 606348	4	
	BARS		Spare Bar	45.003.63	4006825 644609	4	

SCARIFIERS/AERATORS		EARTH AUGER	LAWN TRIMMERS	LAWN EDGE TRIMMER	GROUT CLEANER	SURFACE BRUSH	MULTI-FUNCTIONAL-TOOLS	POLE-MOUNTED PRUNERS
GE-SC 35/1 Li								
GC-SC 36/31 Li	•							
GC-SC 18/28 Li								
GE-SA 1640								
GE-SA 1435								
GE-SA 1433								
GC-SA 1231/1			•					
GC-ES 1231/1								
GC-SC 4240 P			•					
GP-EA 18/150 Li/BL		•						
GE-CT 18 Li		•						
GC-CT 18/24 Li			•					
GC-CT 18/24 Li P			•					
GE-LE 18/190 Li								
GC-CC 18 Li					•			
GC-EG 1410					•			
PICOBELLA						•		
GE-IM 36/4in1 Li							•	
GE-HC 18 Li T							•	
GC-MM 52 I AS							•	
GE-IC 18 Li T							•	
GC-LC 18/20 Li T							•	
GC-EC 7520 T							•	
GC-HC 9024 T							•	

CHAINSAWS / CHAIN SHARPENERS

CHAINS

BARS

GRINDING DISCS

LEAF BLOWER

TILLERS

SHREDDERS

WATERING / DRAINAGE

DIVERSES

HOSES



Spare Chain	45.001.71	4006825 548846	4 006825 548846
Spare Chain	45.001.72	4006825 600926	4 006825 600926
Spare Chain	45.001.73	4006825 663655	4 006825 663655
Spare Chain	45.001.76	4006825 548839	4 006825 548839
Spare Chain	45.001.78	4006825 610321	4 006825 610321
Spare Chain	45.001.92	4006825 663532	4 006825 663532
Spare Chain	45.001.93	4006825 664577	4 006825 664577
Spare Chain	45.001.96	4006825 632231	4 006825 632231
Spare Chain	45.003.13	4006825 663648	4 006825 663648
Spare Chain	45.003.20	4006825 578126	4 006825 578126
Spare Chain	45.017.54	4006825 607024	4 006825 607024
Spare Bar	45.001.51	4006825 548907	4 006825 548907
Spare Bar	45.001.56	4006825 548778	4 006825 548778
Spare Bar	45.001.58	4006825 663846	4 006825 663846
Spare Bar	45.001.62	4006825 610314	4 006825 610314
Spare Bar	45.001.91	4006825 663518	4 006825 663518
Spare Bar	45.001.94	4006825 664560	4 006825 664560
Spare Bar	45.001.97	4006825 632248	4 006825 632248
Spare Bar	45.003.32	4006825 546637	4 006825 546637
Spare Bar	45.003.44	4006825 594188	4 006825 594188
Spare Bar	45.017.53	4006825 607017	4 006825 607017
Spare Grinding Wheel 4.5 mm	45.000.71	4006825 548853	4 006825 548853
Spare Grinding Wheel 3.2 mm	45.000.76	4006825 548860	4 006825 548860
Spare Grinding Wheel 4.5 mm Professional	45.999.80	4006825 552874	4 006825 552874
Spare Grinding Wheel 3.2 mm Professional	45.999.90	4006825 552881	4 006825 552881
Gutter Cleaning Set	34.335.59	4006825 660906	4 006825 660906
Plow	34.315.20	4006825 663419	4 006825 663419
Potato Plow	34.315.30	4006825 663426	4 006825 663426
Spare Blades for Shredders	34.059.30	4006825 595680	4 006825 595680
Electronic Flow Switch	41.742.21	4006825 549225	4 006825 549225
12 cm Prefilter with Cartridge	41.738.01	4006825 549188	4 006825 549188
25 cm Prefilter with Cartridge	41.738.51	4006825 549195	4 006825 549195
4 m Suction Hose with Brass Connectors	41.736.30	4006825 549133	4 006825 549133
4 m Suction Hose with Plastic Connectors	41.736.35	4006825 549058	4 006825 549058
7 m Suction Hose with Brass Connectors	41.736.40	4006825 549171	4 006825 549171
7 m Suction Hose with Plastic Connectors	41.736.45	4006825 549102	4 006825 549102

SALES SUPPORT

POS | SHOP IN SHOP SYSTEM



- **Flagship Shop in Shop Concept**
(according to catalog „Modular Display Concept“)

PRINT PRODUCTS



- **Folders**

- **Brochures**

POS | PERMANENT SECONDARY DISPLAYS



- **Modular Display Power X-Change Garden**
120 x 80 cm
(according to catalog ,Modular Display Concept')



- **Modular Display Power X-Change Power Tools**
120 x 80 cm
(according to catalog ,Modular Display Concept')



- **Wall display Power X-Change Tools + Power Tools**
(according to catalog ,Prime Wall Display Concept')

GARDEN 2022

Is there anything you'd like to ask us about our products?
Would you like to order a part?
Your product isn't working as it should?

We're at your service!
We'll get you some help – fast and without any fuss.



Einhell-Service
Eschenstr. 6
94405 Landau/Isar
Germany



+ 49 (0) 9951 959 2000



+ 49 (0) 9951 959 1700



www.einhell-service.de



Service-DE@einhell.com

Einhell Germany AG
Wiesenweg 22
94405 Landau / Isar – Germany
info@einhell.de – www.einhell.de